

SIEMENS

SIMATIC

Industrial PC SIMATIC IPC477D, IPC477D PRO

Operating Instructions

Preface

Overview

1

Safety instructions

2

Mounting and connecting the device

3

Commissioning the device

4

Operating the device and device functions

5

Expanding the device and assigning device parameters

6

Maintaining and servicing your device

7

Technical information

8

Technical support

A



List of abbreviations

B

Legal information

Warning notice system

This manual contains notices you have to observe in order to ensure your personal safety, as well as to prevent damage to property. The notices referring to your personal safety are highlighted in the manual by a safety alert symbol, notices referring only to property damage have no safety alert symbol. These notices shown below are graded according to the degree of danger.

 DANGER
indicates that death or severe personal injury will result if proper precautions are not taken.
 WARNING
indicates that death or severe personal injury may result if proper precautions are not taken.
 CAUTION
indicates that minor personal injury can result if proper precautions are not taken.
NOTICE
indicates that property damage can result if proper precautions are not taken.

If more than one degree of danger is present, the warning notice representing the highest degree of danger will be used. A notice warning of injury to persons with a safety alert symbol may also include a warning relating to property damage.

Qualified Personnel

The product/system described in this documentation may be operated only by **personnel qualified** for the specific task in accordance with the relevant documentation, in particular its warning notices and safety instructions. Qualified personnel are those who, based on their training and experience, are capable of identifying risks and avoiding potential hazards when working with these products/systems.

Proper use of Siemens products

Note the following:

 WARNING
Siemens products may only be used for the applications described in the catalog and in the relevant technical documentation. If products and components from other manufacturers are used, these must be recommended or approved by Siemens. Proper transport, storage, installation, assembly, commissioning, operation and maintenance are required to ensure that the products operate safely and without any problems. The permissible ambient conditions must be complied with. The information in the relevant documentation must be observed.

Trademarks

All names identified by ® are registered trademarks of Siemens AG. The remaining trademarks in this publication may be trademarks whose use by third parties for their own purposes could violate the rights of the owner.

Disclaimer of Liability

We have reviewed the contents of this publication to ensure consistency with the hardware and software described. Since variance cannot be precluded entirely, we cannot guarantee full consistency. However, the information in this publication is reviewed regularly and any necessary corrections are included in subsequent editions.

Preface

Purpose of the Operating Instructions

These operating instructions contain all the information you need for the commissioning and operation of the SIMATIC IPC477D.

It is intended both for programming and testing personnel who commission the device and connect it with other units (automation systems, programming devices), as well as for service and maintenance personnel who install add-ons or carry out fault/error analyses.

Basic knowledge required

A solid background in personal computers and Microsoft operating systems is required to understand this manual. General knowledge in the field automation control engineering is recommended.

Scope of the operating instructions

These operating instructions apply to "SIMATIC IPC477D" industrial PCs with article numbers 6AV724..... (built-in unit) and 6AV725... (PRO device)

Scope of this documentation

The documentation for the IPC includes the following:

- Product information, e.g. "Important notes on your device"
- Quick Install Guide SIMATIC IPC477D
- Quick Install Guide SIMATIC IPC477D PRO
- Operating Instructions SIMATIC IPC477D, IPC477D PRO

The PDF version of the documentation is supplied with the device on the "Documentation and Drivers" CD/DVD.

Conventions

In these operating instructions, "device" is used as the standard term for "SIMATIC IPC477D" (built-in unit) or "SIMATIC IPC477D PRO" (PRO device). "CP" is used as an abbreviation for "CP 1616 onboard" (for PROFINET) or "CP 5622" (for PROFIBUS).

In these operating instructions, the terms "Windows Embedded Standard 7 P" and "Windows Embedded Standard 7 E" are also abbreviated with the term "Windows Embedded Standard". "Windows 7" is used as an abbreviation for "Windows 7 Ultimate".

A touch device generally refers to a device with a capacitive multi-touch screen or a resistive single touch screen. Touch screen is the general term for a resistive single touch screen or a capacitive multi-touch screen.

Note

A note is important information about the product, handling the product or a reference to specific sections of the documentation that require special consideration.

History

The following editions of these operating instructions have already been published:

Edition	Comments
01/2013	First edition
07/2013	Amendments and corrections
06/2014	Description of devices with capacitive multi-touch screen
11/2014	Update with IPC Wizard 2.1 and corrections
07/2015	Description of the PRO device: fully enclosed, support arm / stand mounting

Table of contents

	Preface	3
1	Overview.....	11
1.1	Product description	11
1.2	Design of the built-in units	14
1.2.1	Devices with resistive single touch screen	14
1.2.2	Devices with capacitive multi-touch screen	15
1.2.3	Touch/Key devices with resistive single touch screen.....	16
1.2.4	Devices with expansions	17
1.2.4.1	Devices with DVD drive	17
1.2.4.2	Devices with PCIe card.....	18
1.2.4.3	Devices with PCIe card and with DVD drive.....	19
1.2.5	Operator controls or touch/key devices with resistive single-touch screen	20
1.2.6	Interfaces and operator controls for devices with 24 V DC power supply	21
1.2.7	Interfaces and operator controls for devices with 240 V AC power supply	22
1.3	Design of the PRO device	23
1.3.1	Structure of the basic adapter.....	24
1.3.2	Interfaces and operator controls for PRO device	24
1.4	Accessory kit.....	25
1.5	Accessories.....	25
2	Safety instructions.....	29
2.1	General safety instructions	29
2.2	Notes on usage.....	32
3	Mounting and connecting the device	35
3.1	Preparing for mounting	35
3.1.1	Checking the delivery package.....	35
3.1.2	Device identification data.....	36
3.1.3	Built-in unit	38
3.1.3.1	Permitted mounting positions	38
3.1.3.2	Preparing the mounting cutout.....	39
3.1.3.3	Labeling the function keys	41
3.1.4	PRO device	43
3.1.4.1	Permitted mounting positions	43
3.2	Installing the built-in unit	43
3.2.1	Installation guidelines.....	43
3.2.2	Mounting clips or mounting brackets, position for IP65-compliant installation	45
3.2.3	Mounting the device with mounting clips	47
3.2.4	Mounting the device with mounting brackets.....	48
3.2.5	Position of the mounting clips for IP66-complaint installation.....	50
3.3	Mounting the PRO device.....	51

3.4	Connecting the device	54
3.4.1	Notes on connecting	54
3.4.2	Power supply built-in unit	56
3.4.2.1	Connecting the protective earth	56
3.4.2.2	Connect 100-240 VAC power supply	57
3.4.2.3	Connecting the terminal	60
3.4.2.4	Connecting the 24 V DC power supply	61
3.4.3	Power supply PRO device	62
3.4.3.1	Opening and closing the terminal compartment cover	62
3.4.3.2	Connecting the PE conductor of the PRO device	64
3.4.3.3	Connecting the 24 V DC power supply PRO device	65
3.4.4	Connecting peripheral equipment	66
3.4.5	Connecting the device to networks	67
3.4.6	PROFINET	68
3.4.7	Securing cables on the built-in unit	70
3.4.7.1	Attaching PROFINET strain relief	71
3.4.8	Securing the cables on the PRO device	72
4	Commissioning the device	73
4.1	General information on commissioning	73
4.2	Initial commissioning	74
4.3	Windows Action Center	75
4.4	Notes on various device configurations	75
4.4.1	SIMATIC IPC Wizard 2.1	75
4.4.1.1	System requirements	76
4.4.1.2	Installing IPC Wizard	77
4.4.2	Notes on the DVD burner	78
5	Operating the device and device functions	79
5.1	Operator input options	79
5.2	Operating a device with resistive single touch screen	80
5.3	Operating a capacitive multi-touch screen device and PRO device	81
5.4	Operating a touch/key device	82
5.5	IPC Wizard functions	85
5.6	Extended device functions	86
5.6.1	Monitoring functions	86
5.6.1.1	Overview of the monitoring functions	86
5.6.1.2	Temperature monitoring/display	86
5.6.1.3	Watchdog (WD)	87
5.6.1.4	Battery monitoring	88
5.6.2	Enhanced Write Filter	88
5.6.3	File Based Write Filter (FBWF)	90
5.6.4	Buffer memory MRAM	92
5.6.5	Active Management Technology (AMT)	92
5.6.6	Trusted Platform Modul (TPM)	94

6	Expanding the device and assigning device parameters	95
6.1	Opening the device	95
6.1.1	Opening the built-in unit.....	95
6.1.2	Opening and closing the backplane cover PRO device	97
6.2	Installing and removing a memory module	99
6.3	Removing a PCIe card (built-in units with PCIe card without DVD drive)	101
6.4	Removing a PCIe card (built-in units with PCIe card and DVD drive).....	103
6.5	Installing and removing a DVD drive (built-in unit only).....	103
6.6	Installing and removing a CFast card	105
6.6.1	Installing and removing a CFast card (external slot)	105
6.6.2	Installing and removing a CFast card (internal slot)	106
7	Maintaining and servicing your device	109
7.1	Maintenance	109
7.2	Repair information.....	109
7.3	Cleaning the Device Front	112
7.4	Installing and removing hardware	113
7.4.1	Built-in unit	113
7.4.1.1	Replacing back-up battery (device with 12" display)	113
7.4.1.2	Replacing back-up battery (devices with 15", 19" or 22" display)	114
7.4.1.3	Replacing SSD (device with 12" display).....	115
7.4.1.4	Replacing the SSD (devices with 15", 19" or 22" display).....	116
7.4.1.5	Replacing HDD	118
7.4.2	PRO device	119
7.4.2.1	Replacing the backup battery (PRO device)	119
7.4.2.2	Replacing the SSD (PRO device).....	120
7.5	Installing the software	121
7.5.1	Reinstalling the operating system.....	121
7.5.1.1	General installation procedure	121
7.5.1.2	Restoring the factory state of the software using the Restore DVD	122
7.5.1.3	Windows 7	123
7.5.1.4	Windows Embedded Standard	126
7.5.2	Partitioning data media	127
7.5.2.1	Partitioning in Windows Embedded Standard 7	127
7.5.2.2	Partitioning in Windows 7 Ultimate	127
7.5.2.3	Adapting partitions in Windows 7 Ultimate and Windows Embedded Standard 7	128
7.5.3	Installing drivers and software	129
7.5.4	Update installation	129
7.5.4.1	Updating the operating system	129
7.5.4.2	Installing or updating application programs and drivers	130
7.5.4.3	CP 1616 onboard.....	130
7.5.5	Backing up data	130
7.6	Recycling and disposal	130

8	Technical information	131
8.1	Certificates and approvals	131
8.2	Directives and declarations	132
8.2.1	ESD guideline	133
8.3	Dimension drawings.....	135
8.3.1	Dimension drawing of 15" device with capacitive multi-touch screen	135
8.3.2	Dimension drawing of 19" device with capacitive multi-touch screen	136
8.3.3	Dimension drawing of 22" device with capacitive multi-touch screen	137
8.3.4	Dimension drawing 19" PRO device with capacitive multi-touch screen.....	138
8.3.5	Dimension drawing of 12" device with resistive single-touch screen	139
8.3.6	Dimension drawing of 15" device with resistive single-touch screen	140
8.3.7	Dimension drawing of 19" device with resistive single-touch screen	141
8.3.8	Dimension drawing of 22" device with resistive single-touch screen	142
8.3.9	Dimension drawing of 15" touch/key device with resistive single-touch screen	143
8.3.10	Dimension drawing of labeling strips	144
8.4	Technical specifications	145
8.4.1	Built-in unit	145
8.4.1.1	General technical specifications	145
8.4.1.2	Environmental conditions	149
8.4.2	PRO device	152
8.4.2.1	General specifications PRO device	152
8.4.2.2	Ambient conditions PRO device	155
8.4.2.3	Information on insulation tests, protection class and degree of protection.....	156
8.4.2.4	Rated voltages	156
8.4.3	Power requirements of the components	157
8.4.4	Integrated DC power supply	157
8.4.5	AC voltage supply	158
8.5	Hardware descriptions	159
8.5.1	External ports	159
8.5.1.1	COM1/COM2	159
8.5.1.2	CFast.....	159
8.5.1.3	DisplayPort.....	160
8.5.1.4	DVI-I.....	161
8.5.1.5	Ethernet.....	162
8.5.1.6	USB 3.0 port.....	162
8.5.1.7	USB 2.0.....	163
8.5.1.8	PROFIBUS.....	163
8.5.1.9	PROFINET	164
8.5.2	Internal ports	164
8.5.2.1	PCIe card	164
8.5.3	System resources	166
8.5.3.1	Currently allocated system resources.....	166
8.5.3.2	Assignment of system resources	166
8.5.4	I/O Address Areas.....	167
8.5.4.1	Overview of the internal module registers	167
8.5.4.2	Watchdog trigger register (read only, address 066h)	167
8.5.4.3	Watchdog enable register / 066h select register (read/write, address 062h)	168
8.5.4.4	Battery status register (read-only, address 50Ch).....	169
8.5.4.5	MRAM address register	169
8.5.5	CP 1616 onboard communications processor.....	169

8.5.5.1	Introduction	169
8.5.5.2	Firmware Loader.....	171
8.5.5.3	Further actions in STEP 7/NCM PC	173
8.6	BIOS description	173
8.6.1	Overview	173
8.6.2	Opening the BIOS selection menu	174
8.6.3	Configuration.....	175
8.6.4	Exit menu	176
8.6.5	General BIOS Setup settings.....	177
8.6.6	BIOS update	181
8.6.7	Alarm, error and system messages	182
8.7	Active Management Technology (AMT)	182
8.7.1	Introduction	182
8.7.2	Overview of AMT	183
8.7.3	Enabling Intel® AMT / basic configuration.....	184
8.7.4	Resetting the Intel® AMT to the default settings and disabling AMT	185
8.7.5	Determining the network address	185
8.7.6	Forcing user consent	186
8.8	Functional scope in Windows	187
8.8.1	Windows Embedded Standard 7	187
A	Technical support.....	189
A.1	Service and support.....	189
A.2	Problem solving	189
A.3	Notes on the use of third-party modules.....	191
B	List of abbreviations	193
	Glossary	199
	Index.....	207

Overview

1.1 Product description



Features

The SIMATIC IPC477D provides high-level industrial functionality.

- Compact design
- Maintenance-free operation
- Rugged

In addition to the established display sizes, the range has been extended by the PRO device with all-round IP65 degree of protection; the device not only impresses with its ease of servicing, but also with its sophisticated design and low mounting depth.

Device variants

The delivery note contains information on the precise scope of functions and product package for your device.

The SIMATIC IPC477D is available in the following device variants, which differ in regard to the display size, operating method and optional expansions:

Built-in units with capacitive multi-touch screen

- Display:
 - 15.6" display, resolution: 1366 x 768 pixels
 - 19" display, resolution: 1366 x 768 pixels
 - 22" display, resolution: 1920 x 1080 pixels
- with DVD drive
- with PCIe slot
- with DVD drive and PCIe slot

PRO device with capacitive multi-touch screen

- Display:
 - 19" display, resolution: 1366 x 768 pixels
- Can be optionally mounted on a support arm or stand
- A base adapter and adapter sets that can be ordered separately support mounting systems from various manufacturers.
- Fully dust-proof and splash-proof with IP65 degree of protection and Enclosure Type 4X / 12 (indoor use only)
- With SSD:

The following options are not available for PRO devices:

- Hard disk drive
- DVD drive
- PCI expansion
- 2nd COM interface
- 230 V AC power supply

Devices with resistive single touch screen

- Display:
 - 12" display, resolution: 1280 x 800 pixels
 - 15" display, resolution: 1280 x 800 pixels
 - 19" display, resolution: 1366 x 768 pixels
 - 22" display, resolution: 1920 x 1080 pixels
- with DVD drive (not for device with 12" display)
- with PCIe slot (not for device with 12" display)
- with DVD drive and PCIe slot (not for device with 12" display)

Touch/Key devices with resistive single touch screen

- Display:
 - 15" display, resolution: 1280 x 800 pixels
- with DVD drive
- with PCIe slot
- with DVD drive and PCIe slot
- Membrane keyboard with alphanumeric keys, numeric keys, cursor keys, control keys, function keys, and softkeys

Operating systems

The following table shows which operating systems are available for which devices:

Display	Operating system		
	Windows 7 Ultimate (32/64-bit)	Windows Embedded Standard 7 P (32/64-bit)	Windows Embedded Standard 7 E (32/64-bit)
Devices with resistive single touch screen	x		x
Devices with capacitive multi-touch screen	x	x	
Touch/key devices	x		x

1.2 Design of the built-in units

1.2.1 Devices with resistive single touch screen

The following figures show the 12" device as an example.

Front and side views

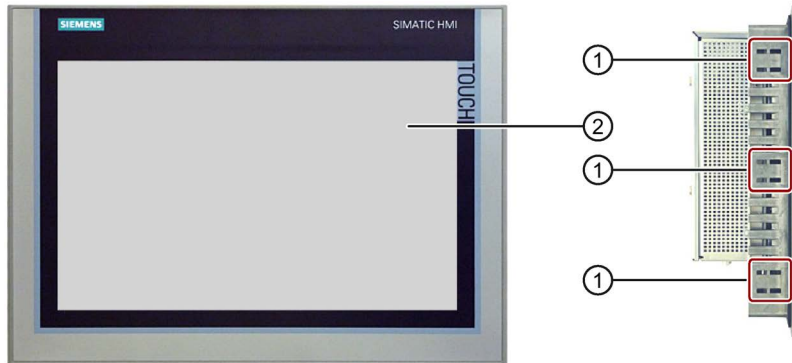

- ① Recesses, each of which for a mounting clip
- ② Display with touch screen

Bottom view

The bottom view shows a device with 24 V DC power supply and PROFIBUS interface.



- ① Recesses, each for a mounting clip

Rear view

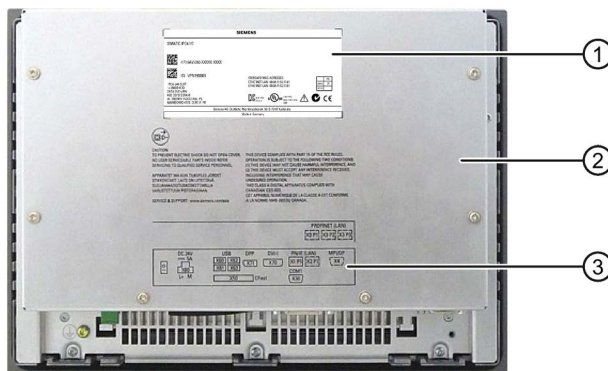

- ① Rating plate
- ② Rear panel
- ③ Labeling for the interface arrangement

1.2.2 Devices with capacitive multi-touch screen

The following figures show the 19" device without DVD drive and without PCIe card as an example.

Front and side views

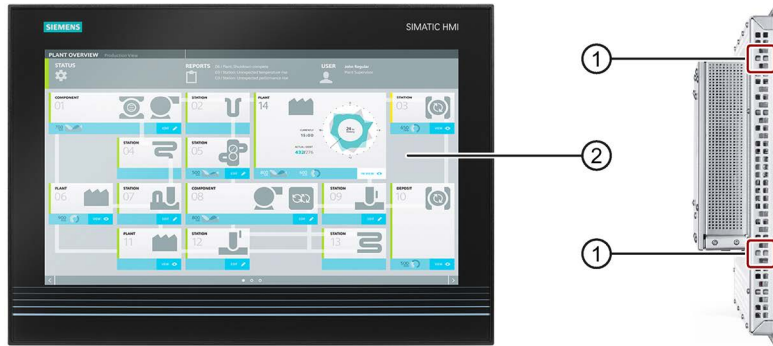

- ① Recesses, each of which for a mounting clip
- ② Display with touch screen

Bottom view

The bottom view shows a device with 24 VDC power supply without fieldbus interface.



- ① Recesses, each for a mounting clip

Rear view



- ① Rating plate
- ② Rear panel
- ③ Labeling for the interfaces

1.2.3 Touch/Key devices with resistive single touch screen

The following figures show the Touch/Key device (15" only) without DVD drive and without PCIe card as an example.

Front and side views



- ① Recesses, each of which for a mounting clip
- ② Display with touch screen
- ③ USB port

Bottom view

The bottom view shows a device with 24 V DC power supply and PROFIBUS interface.

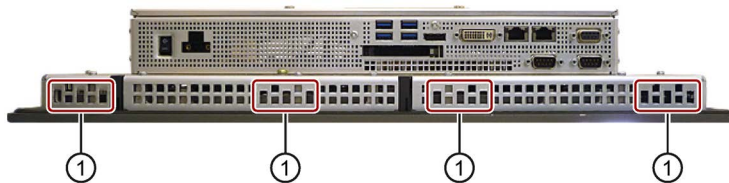

- ① Recesses, each of which for a mounting clip

Rear view

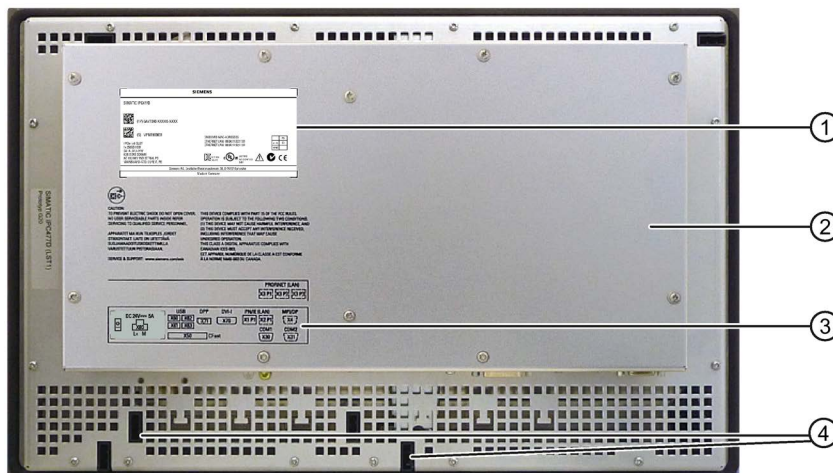

- ① Rating plate
- ② Rear panel
- ③ Labeling for the interface arrangement
- ④ Guides for labeling strips

1.2.4 Devices with expansions

1.2.4.1 Devices with DVD drive

The following figures show the 15" device with resistive single-touch screen as an example.

Rear view and side view

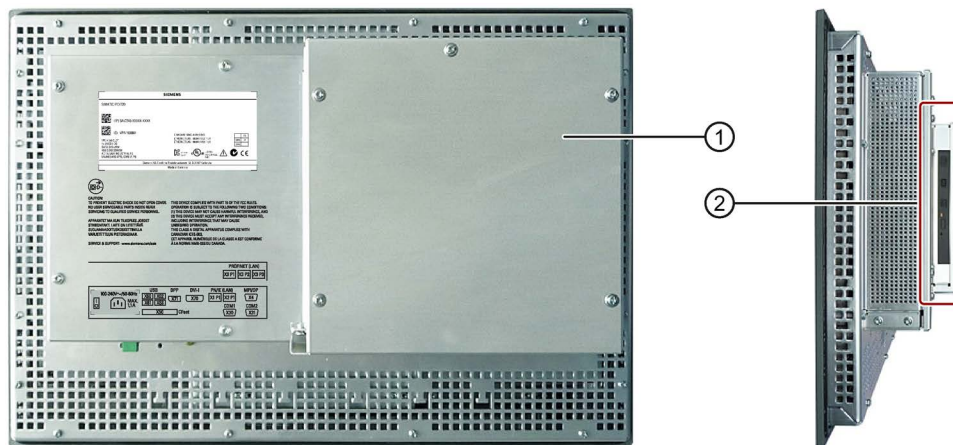

- ① Rear panel
- ② DVD drive

Bottom view



1.2.4.2 Devices with PCIe card

The following figures show the 15" device with resistive single-touch screen as an example.

Rear view and side view

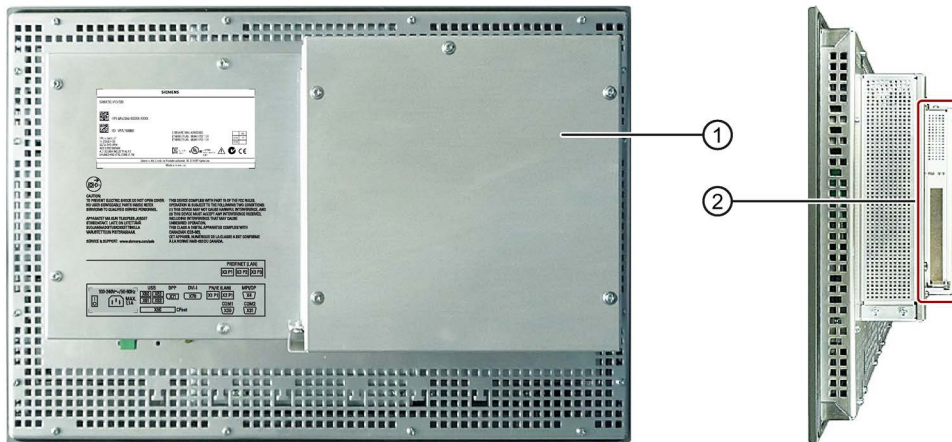

- ① Rear panel
- ② PCIe card

Bottom view



1.2.4.3 Devices with PCIe card and with DVD drive

The following figures show the 15" device with resistive single-touch screen as an example.

Rear view and side view

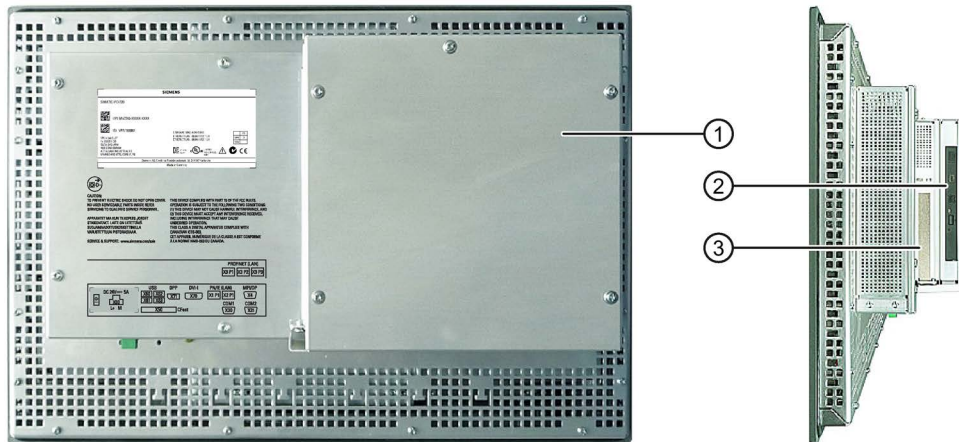

- ① Rear panel
- ② DVD drive
- ③ PCIe card

Bottom view



1.2.5 Operator controls or touch/key devices with resistive single-touch screen

Note

If you open the sealed cover for the front USB port, the degree of protection IP65 for the front of the device is no longer guaranteed.

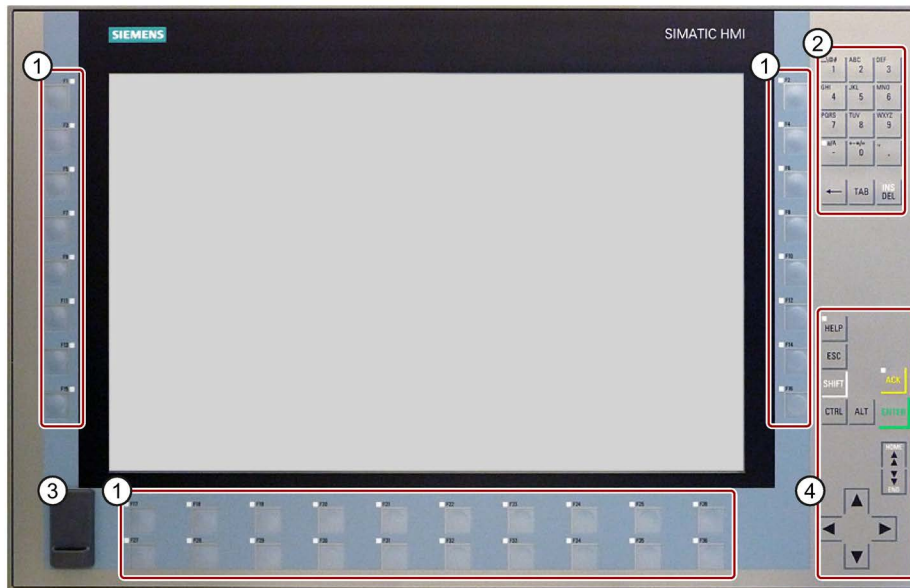

- ① Function keys
- ② Keypad with alphanumeric and numeric keys
- ③ Sealed cover for the USB port
- ④ Control keys, cursor keys, On/Off switch

1.2.6 Interfaces and operator controls for devices with 24 V DC power supply

The figures showing the interfaces apply to the following devices:

- IPC477D with 12" display
- IPC477D with 15" display
- IPC477D with 19" display
- IPC477D with 22" display

Devices with PROFIBUS interface

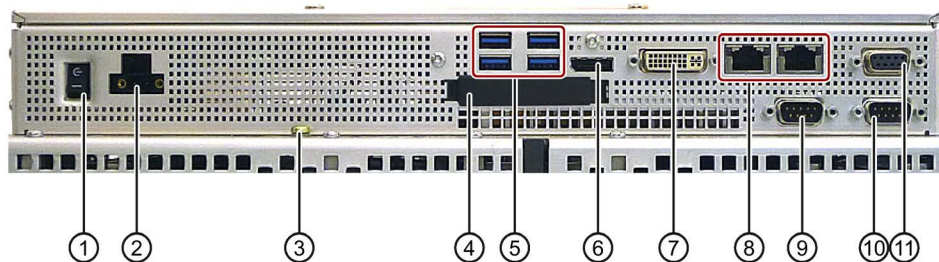

- | | |
|-----------------------------------|--|
| ① On/Off switch | |
| ② 24 V DC power supply | |
| ③ Protective conductor connection | |
| ④ Slot for external CFast card | With cover |
| ⑤ 4 x USB port | USB 3.0 high speed/high current |
| ⑥ Display port | |
| ⑦ DVI-I port | DVI connector for CRT or LCD monitor (VGA via DVI-VGA adapter) with DVI interface |
| ⑧ 2 x Ethernet port | RJ45 Ethernet connection 1 for 10/100/1000 Mbps or RJ45 Ethernet connection 2 for 10/100/1000 Mbps (not for PROFINET device) |
| ⑨ COM 1 port | Serial interface, 9-pin D-sub plug |
| ⑩ COM 2 port | Serial interface, 9-pin D-sub plug |
| ⑪ PROFIBUS DP/MPI interface | PROFIBUS DP/MPI interface RS 485, isolated, 9-pin D-sub socket |

Devices with PROFINET interfaces

The unnamed interfaces in the following figure are identical to those on the PROFIBUS device.



- | | |
|---------------------------|---------------------------------------|
| ① 3 x PROFINET interfaces | CP-1616 onboard ports via RJ45 socket |
|---------------------------|---------------------------------------|

1.2.7 Interfaces and operator controls for devices with 240 V AC power supply

The figures showing the interfaces apply to the following devices:

- IPC477D with 15" display
- IPC477D with 19" display
- IPC477D with 22" display

Devices with PROFIBUS interface

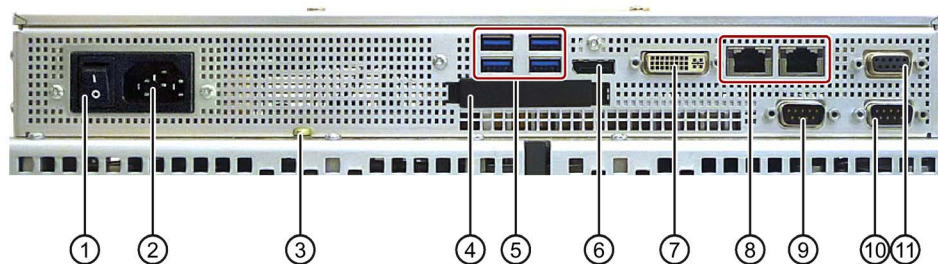

- | | | |
|---|---------------------------------|--|
| ① | On/Off switch | |
| ② | 240 V AC power supply | |
| ③ | Protective conductor connection | |
| ④ | Slot for external CFast card | With cover |
| ⑤ | 4 x USB port | USB 3.0 high speed/high current |
| ⑥ | Display port | |
| ⑦ | DVI-I port | DVI connector for CRT or LCD monitor (VGA via DVI-VGA adapter) with DVI interface |
| ⑧ | 2 x Ethernet port | RJ45 Ethernet connection 1 for 10/100/1000 Mbps or RJ45 Ethernet connection 2 for 10/100/1000 Mbps (not for PROFINET device) |
| ⑨ | COM 1 port | Serial interface, 9-pin D-sub plug |
| ⑩ | COM 2 port | Serial interface, 9-pin D-sub plug |
| ⑪ | PROFIBUS DP/MPI interface | PROFIBUS DP/MPI interface RS 485, isolated, 9-pin D-sub socket |

Devices with PROFINET interfaces

The unnamed interfaces in the following figure are identical to those on the PROFIBUS device.



- | | | |
|---|------------------------|---------------------------------------|
| ① | 3 x PROFINET interface | CP-1616 onboard ports via RJ45 socket |
|---|------------------------|---------------------------------------|

1.3 Design of the PRO device

Front view and side view

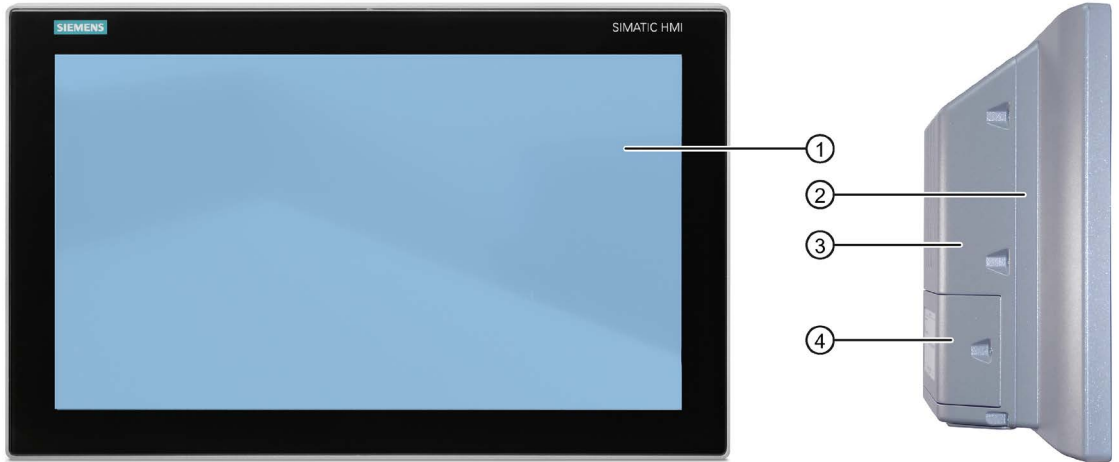

- ① Display with multi-touch screen
- ② Enclosure
- ③ Backplane cover
- ④ Terminal compartment cover

Bottom view



- ① Mechanical interface for mounting/base adapter

Rear view



- ① Backplane cover
- ② Terminal compartment cover
- ③ Mechanical interface for mounting/base adapter

1.3.1 Structure of the basic adapter

The base adapter comes with an adapter set. The base adapter and adapter set are required for mounting on a support arm or stand and are available as accessories.

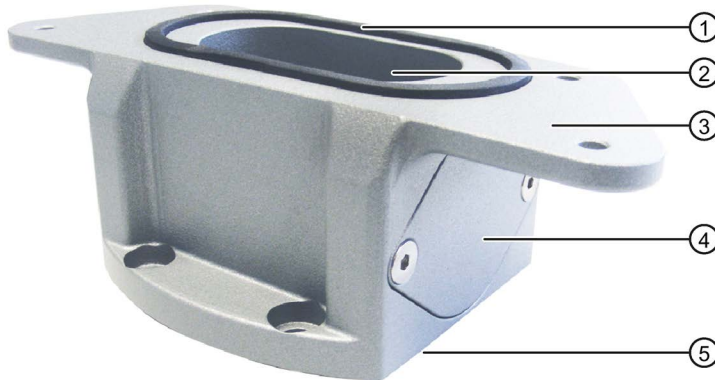

- ① Seal
- ② Cable channel
- ③ Mechanical interface to the PRO device
- ④ Cover
- ⑤ Mechanical interface to support arm or stand

1.3.2 Interfaces and operator controls for PRO device

The figure of the interfaces applies to the PRO device. The assignment of the interfaces is shown inside the terminal compartment cover.

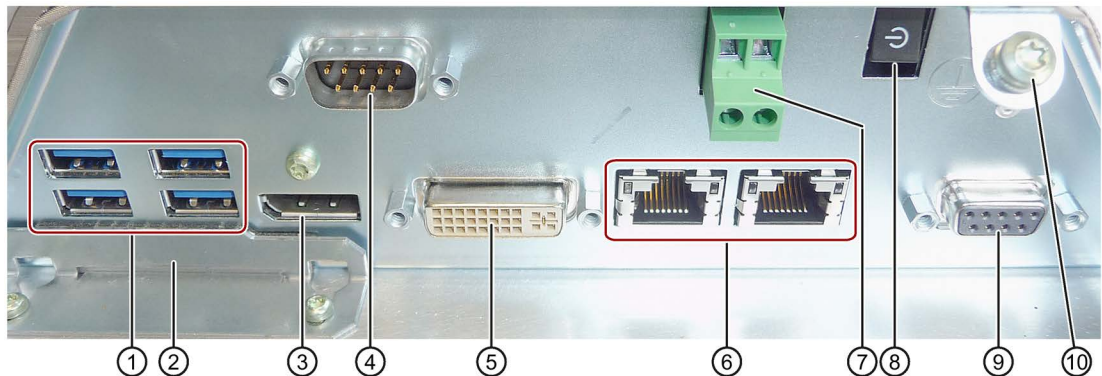

- ① 4 x USB port
 - ② Slot for external CFast card
 - ③ Display port
 - ④ COM1 port
 - ⑤ DVI-I port
 - ⑥ 2 x Ethernet port
 - ⑦ 24 V DC power supply
 - ⑧ On/off switch
 - ⑨ PROFIBUS-DP/MPI interface (optional)
 - ⑩ Protective conductor connection
- USB 3.0 high speed/high current
 - Behind the cover
 - DPP
 - Serial interface, 9-pin D-sub connector
 - DVI connector for CRT or LCD monitor (VGA via DVI-VGA adapter) with DVI interface
 - RJ45 Ethernet connection 1 and 2 for 10/100/1000 Mbps
 - interface RS 485, isolated, 9-pin D-sub socket

1.4 Accessory kit

Accessory kit for built-in unit

The accessory kit contains:

- Connection terminal for connection of power supply
- Mounting clips for mounting the HMI device

Additional documents may be enclosed with the accessory kit.

For PRO device

- The connection terminal for connection of the power supply is plugged in.
- The base adapter for mounting on a support arm or stand must be ordered separately.

1.5 Accessories

Accessories are available for your device. These are not included in the product package. You can find Information on available accessories on the Internet at:

Industry Mall (<https://mall.industry.siemens.com>)

Expansion components and accessories (http://www.automation.siemens.com/mcmsg/pc-based-automation/en/industrial-pc/expansion_components_accessories)

SIMATIC IPC CFast cards

- 2 GB
- 4 GB
- 8 GB
- 16 GB

Production version of the SIMATIC IPC CFast card

Note

Only SIMATIC IPC CFast cards with production version 02 or higher may be used with this device.

The production version can be found on the CFast card (see marking).



Memory modules

- SO-DIMM module 1024 MB DDR3-SDRAM or
- SO-DIMM module 2048 MB DDR3-SDRAM or
- SO-DIMM module 4096 MB DDR3-SDRAM or
- SO-DIMM module 8192 MB DDR3-SDRAM

Other accessories

- Touch stylus only for devices with resistive single-touch screen

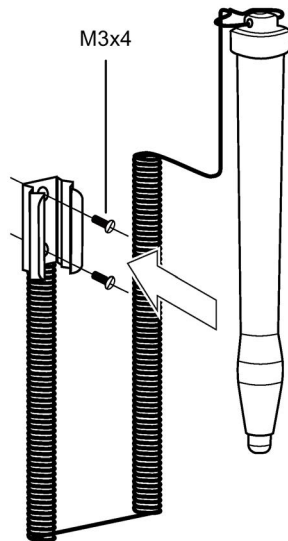

- Mounting bracket

If there are higher requirements for the front seal, fasten the device with mounting brackets in a control cabinet.

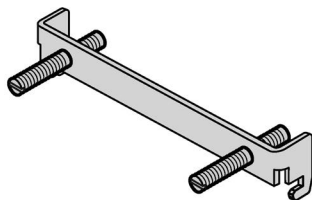

RS 422 to RS 232 converter

The converter is required to connect controllers from other manufacturers. Connect the RS 422 to RS 232 converter to the RS 422 / RS 485 interface. The converter converts the input signals to RS 232 signals.

Article number of the converter RS 422 to RS 232: 6AV6 671-8XE00-0AX0.

90° elbow adapter

If space is limited, you can use an elbow adapter at the RS 422/RS 485 interface.

Article number of the 90° elbow adapter: 6AV6 671-8XD00-0AX0.

Base adapter for support arm and stand mounting of PRO device

The Siemens base adapter is not included in the product package, but can be ordered as an option.

Article number for the base adapter as accessory: 6AV7674-1KA00-0AA0.

Support arm and stand mounting of PRO device

The PRO device can be mounted on a support arm and stand systems from third-party vendors (see section "Mounting the PRO device (Page 51)"). For this you will need the Siemens base adapter (see above) and a proprietary adapter set. Siemens also offers its own adapter for VESA-compatible third-party systems:

Adapter set	Suitable for support arm systems	Article number
SIEMENS: <ul style="list-style-type: none"> • Adapter set VESA75 • Adapter set VESA100 	<ul style="list-style-type: none"> • VESA75-compatible systems • VESA100-compatible systems 	<ul style="list-style-type: none"> • 6AV7674-0KE00-0AA0 • 6AV7674-0KD00-0AA0
RITTAL: Adapter for Siemens PRO Panel <ul style="list-style-type: none"> • Intermediate plate • Screws 	<ul style="list-style-type: none"> • CP40 steel • CP60/120 for Support arm connection 120 × 65 mm 	6206.500
ROLEC: Adapter for Siemens PRO Panel <ul style="list-style-type: none"> • Intermediate plate • Screws 	<ul style="list-style-type: none"> • profiPlus-50 • taraPLUS for Ø 65 mm hole circle 	142.024.000
BERNSTEIN: Coupling for Siemens SIMATIC PRO <ul style="list-style-type: none"> • No intermediate plate required • Coupling with integrated adaptation for PRO device 	<ul style="list-style-type: none"> • CS-3000 	<ul style="list-style-type: none"> • 1015300187 RAL 9006 white aluminum • 1015300043 RAL 7016 anthracite gray

Information provided without guarantee.

Safety instructions

2.1 General safety instructions

 WARNING
Life-threatening voltages are present with an open control cabinet
When you install the device in a control cabinet, some areas or components in the open control cabinet may be carrying life-threatening voltages.
If you touch these areas or components, you may be killed by electric shock.
Switch off the power supply to the cabinet before opening it.

System expansions

NOTICE
Damage through system expansions
Device and system expansions may be faulty and can affect the entire machine or plant.
The installation of expansions can damage the device, machine or plant. Device and system expansions may violate safety rules and regulations regarding radio interference suppression. If you install or exchange system expansions and damage your device, the warranty becomes void.
Note the following for system expansions:
<ul style="list-style-type: none">• Only install system expansion devices designed for this device. Contact your technical support team or where you purchased your PC to find out which system expansion devices may safely be installed.• Read the information on electromagnetic compatibility (Page 132).

NOTICE
"Open Type" UL508
Note that the built-in unit is classified as "Open Type" for use in the area of Industrial Control Equipment (UL508). The installation of the built-in unit in an enclosure conforming to UL508 is a mandatory requirement for approval and operation in accordance with UL508.

Battery and rechargeable battery

 WARNING
Risk of explosion and release of harmful substances Improper handling of lithium batteries can result in an explosion of the batteries. Explosion of the batteries and the released pollutants can cause severe physical injury. Worn batteries jeopardize the function of the device. Note the following when handling lithium batteries: <ul style="list-style-type: none">• Replace spent batteries promptly. You can find information on installing and removing the backup battery in the Operating Instructions.• Replace the lithium battery only with an identical battery or types recommended by the manufacturer.• Do not throw lithium batteries into fire, do not solder on the cell body, do not recharge, do not open, do not short-circuit, do not reverse polarity, do not heat above 100°C and protect from direct sunlight, moisture and condensation.

Strong high-frequency radiation

NOTICE
Observe immunity to RF radiation The device has an increased immunity to RF radiation according to the specifications on electromagnetic compatibility in the technical specifications. Radiation exposure in excess of the specified immunity limits can impair device functions, result in malfunctions and therefore injuries or damages. Read the information on immunity to RF radiation in the technical specifications.

ESD Guideline



Electrostatic sensitive devices can be labeled with an appropriate symbol.

NOTICE
Electrostatic sensitive devices (ESD) When you touch electrostatic sensitive components, you can destroy them through voltages that are far below the human perception threshold. If you work with components that can be destroyed by electrostatic discharge, observe the ESD Guideline (Page 133).

Industrial Security

Siemens offers products and solutions with Industrial Security functions that support the safe operation of equipment, solutions, machines, devices and/or networks. They are important components in a comprehensive Industrial Security concept. As a result the products and solutions from Siemens are constantly evolving. Siemens recommends obtaining regular information regarding product updates.

For safe operation of Siemens products and solutions appropriate protective measures (e.g., cell protection concept) must be taken and each component must be integrated in a comprehensive Industrial Security concept, which corresponds with the current state of technology. The products of other manufacturers need to be taken into consideration if they are also used. You can find addition information on Industrial Security under (<http://www.siemens.de/industrialsecurity>).

Sign up for our product-specific newsletter to receive the latest information on product updates. For more information, see under (http://www.siemens.de/automation/csi_en_WW).

Disclaimer for third-party software updates

This product includes third-party software. Siemens AG only provides a warranty for updates/patches of the third-party software, if these have been distributed as part of a Siemens software update service contract or officially released by Siemens AG. Otherwise, updates/patches are undertaken at your own risk. You can find more information about our Software Update Service offer on the Internet at Software Update Service (<http://www.automation.siemens.com/mcms/automation-software/de/software-update-service/Seiten/Default.aspx>).

Notes on protecting administrator accounts

A user with administrator privileges has extensive access and manipulation options in the system.

Therefore, ensure there are adequate safeguards for protecting the administrator accounts to prevent unauthorized changes. To do this, use secure passwords and a standard user account for normal operation. Other measures, such as the use of security policies, should be applied as needed.

2.2 Notes on usage

 WARNING
Risks associated with the unprotected machine or plant
According to the results of a risk analysis, certain hazard potentials associated with the unprotected machine exist. These hazards could lead to personal injury.
Avoid such hazards by taking the following precautions in accordance with the risk analysis:
<ul style="list-style-type: none">• Installation of additional safety equipment on the machine or plant. In particular, the programming, parameter assignment and wiring of the inserted I/O modules must be executed in accordance with the safety performance identified by the necessary risk analysis (SIL, PL or Cat.).• Use as intended must be validated for the device by means of a function test on the plant. These tests help you to identify programming, parameter assignment and wiring errors.• Documentation of the test results that you can enter in the relevant safety verification documents, if necessary.

Environment

NOTICE
Ambient conditions and chemical resistance
Unsuitable environmental conditions have a negative impact on device operation. Chemical substances such as cleaners or fuels may alter the color, shape and structure of the device surface, for example, the front panel.
The device may be damaged, possibly resulting in malfunctions.
For this reason, please observe the following precautions:
<ul style="list-style-type: none">• Always operate the device in closed rooms. All warranties shall be void in the case of noncompliance.• Operate the device only in accordance with the ambient conditions specified in the technical specifications.• Protect the device against dust, moisture and heat.• Do not expose the device to direct sunlight or to other strong sources of light.• Without additional safety measures, such as a supply of clean air, the device may not be used in locations with harsh operating conditions caused by acidic vapors or gases.• Always use suitable cleaning agents. Read the information about Chemical resistance of the HMI devices and industrial PCs (http://support.automation.siemens.com/WW/view/en/39718396) on the Internet.

Note

Use in an industrial environment without additional protective measures

The device has been designed for use in a normal industrial environment in accordance with IEC 60721-3-3 (pollutant class 3C2 for chemical influences, 3S2 for dust without sand).

TFT displays

NOTICE

Burn-in effect and backlighting

A permanent picture with bright screen objects leads to a burn-in effect. The longer the same screen contents are displayed, the longer it will take for the burn-in effect to disappear. Screensavers (for example, "starfield simulation") for the backlit active black mode reduce the burn-in effect. The brightness of the backlighting deteriorates over the course of the screen's life cycle.

The service life of the screen and backlighting is extended by the following measures:

- Switch on the screensaver. The backlight brightness is reduced while the screensaver is active.
- You should also reduce the backlighting.
- Observe the backlighting operating time.

Defective pixels in the display

At present, the manufacturing process of modern displays does not guarantee that all pixels of the display will be perfect. A small number of defective pixels in the display is therefore unavoidable. This does not present a functional problem as long as the defective pixels are not bunched in one location.

Additional information is available in the section "General technical specifications (Page 145)".

Mounting and connecting the device

3.1 Preparing for mounting

3.1.1 Checking the delivery package

Procedure

1. When accepting a delivery, please check the packaging for visible transport damage.
2. If any transport damage is present at the time of delivery, lodge a complaint at the shipping company in charge. Have the shipper confirm the transport damage immediately.
3. Unpack the device at its installation location.
4. Keep the original packaging in case you have to transport the unit again.

Note

Damage to the device during transport and storage

If a device is transported or stored without packaging, shocks, vibrations, pressure and moisture may impact the unprotected unit. Damaged packaging indicates that ambient conditions have already had a massive impact on the device and it may be damaged.

This may cause the device, machine or plant to malfunction.

- Keep the original packaging.
 - Pack the device in the original packaging for transportation and storage.
-

5. Check the contents of the packaging and any accessories you may have ordered for completeness and damage.
6. Please inform the delivery service immediately if the package contents are incomplete or damaged or do not correspond with your order. Fax the enclosed form "SIMATIC IPC/PG Quality Control Report".

 WARNING
--

Electric shock and fire hazard due to damaged device

A damaged device can be under hazardous voltage and trigger a fire in the machine or plant. A damaged device has unpredictable properties and states.

Death or serious injury could occur.

Make sure that the damaged device is not inadvertently installed and put into operation. Label the damaged device and keep it locked away. Send off the device for immediate repair.
--

3.1 Preparing for mounting

<p>NOTICE</p> <p>Damage from condensation</p> <p>If the device is subjected to low temperatures or extreme fluctuations in temperature during transportation, as is the case in cold weather, for example, moisture can build up on or inside the device (condensation).</p> <p>Moisture causes a short circuit in electrical circuits and damages the device.</p> <p>In order to prevent damage to the device, proceed as follows:</p> <ul style="list-style-type: none"> • Store the device in a dry place. • Bring the device to room temperature before starting it up. • Do not expose the device to direct heat radiation from a heating device. • If condensation develops, wait approximately 12 hours or until the device is completely dry before switching it on.
--

7. Please keep the enclosed documentation in a safe place. It belongs to the device. You need the documentation when you commission the device for the first time.
8. Write down the identification data of the device.

3.1.2 Device identification data







Unpacking the device

The device can be clearly identified with the help of this identification data in case of repairs or theft.

Enter the identification data in the table below:

Identification data	Source	Value
Serial number	Rating plate	S VP ...
Article number of the device	Rating plate	6AV724.... (SIMATIC IPC477D)
Microsoft Windows Product Key Certificate of Authenticity (COA)	Back of the device	Only devices with preinstalled Windows operating systems have the COA label
Ethernet address 1	BIOS setup, "Main" menu	
Ethernet address 2 (not for PROFINET devices)		
CP 1616 onboard MAC Address Layer 2 (only for PROFINET devices)		
CP 1616 onboard MAC address PROFINET (only for PROFINET devices)		

Example of rating plate on SIMATIC IPC477D

SIEMENS							
<p>SIMATIC IPC477D PRO</p>  (1P) 6AV724X-XXXX-XXXX  (S) VPN1900001 <p>250GB HDD 4GB DDR3 SDRAM DC 24V INDUSTRIAL PS MAINBOARD 477D, CORE i7, PB 19" MULTI-TOUCH RS232 WINDOWS EMBEDDED 7 P SP1</p>	<p>SERVICE & SUPPORT: WWW.SIEMENS.COM/ASIS ENCLOSURE TYPE 4X, TYPE 12 INDOOR USE ONLY, WATERTIGHT THIS DEVICE COMPLIES WITH PART 15 OF THE FCC RULES. OPERATION IS SUBJECT TO THE FOLLOWING TWO CONDITIONS: (1) THIS DEVICE MAY NOT CAUSE HARMFUL INTERFERENCE, AND (2) THIS DEVICE MUST ACCEPT ANY INTERFERENCE RECEIVED, INCLUDING INTERFERENCE THAT MAY CAUSE UNDESIRE OPERATION. CAN ICES-3(A)/NMB-3(A) ONBOARD MAC-ADDRESSES: ETHERNET LAN: 08:0A:11:52:11:01 ETHERNET LAN: 08:0A:11:52:11:55 CP1616 onboard Layer2: 08:0C:11:AA:11:01</p> <table border="1" data-bbox="1066 457 1136 521"> <tr><td></td><td>FS</td></tr> <tr><td>VERS</td><td></td></tr> <tr><td>AEAD</td><td></td></tr> </table> <p>  KCC-REM-549-IPC  US LISTED IND.CONT.EQ. E85972   </p>		FS	VERS		AEAD	
	FS						
VERS							
AEAD							
<p>Siemens AG, Gleiwitzer Str. 555, DE-90475 Nuremberg Made in Germany</p>							

COA label

Microsoft Windows "Product Key" from the "Certificate of Authenticity" (COA):

The COA label is present only when Windows Embedded Standard 7 or Windows 7 is installed.

- COA label of a device with the Windows Embedded Standard 7 operating system

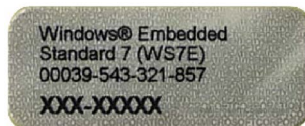

- COA label of a device with the Windows 7 operating system

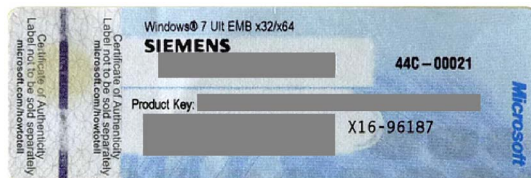

For a PRO device, the COA label is attached to the strain relief and can only be seen after removing the terminal compartment cover.

3.1.3 Built-in unit

3.1.3.1 Permitted mounting positions

The mounting positions described below are permitted for the built-in unit. For information on the maximum permissible ambient temperatures during operation, see section "Environmental conditions (Page 149)".

 CAUTION
Danger from high temperature of the enclosure if built-in unit is touched
Self-heating can cause the temperature of the built-in unit to exceed 70 °C during operation at an ambient temperature > 45 °C.
If you want to operate the built-in unit at an ambient temperature > 45 °C, you will have to install it in a Restricted Access Location (RAL) such as a lockable control cabinet.

- Standard mounting position: Vertical installation in horizontal format
In this mounting position, the device enclosure satisfies the requirements of a fire protection enclosure.

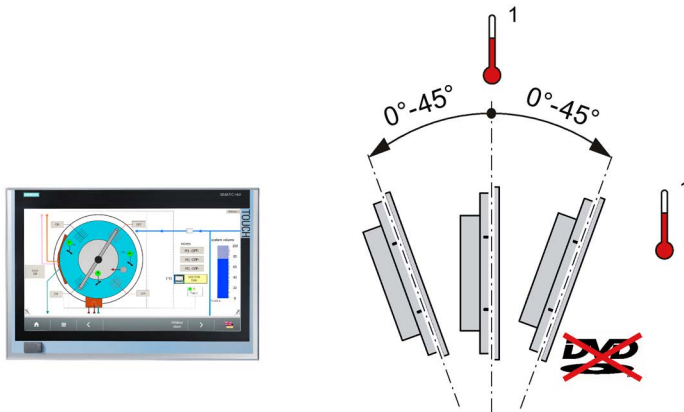

¹ For temperature specifications, see section "Environmental conditions (Page 149)".

- Inclined installation in horizontal format with a vertical inclination of maximum $\pm 45^\circ$
In an inclined mounting position, the device enclosure satisfies the requirements of a fire protection enclosure.
In an inclined mounting position, operation of the DVD drive is not permitted.
- Upright mounting in vertical format (only permitted for the built-in unit)

<p>⚠ CAUTION</p> <p>Fire protection enclosure requirement not fulfilled</p> <p>In the "Upright mounting in vertical position" mounting position, the device enclosure does not satisfy the requirement of a fire protection enclosure.</p> <p>If you want to operate the built-in unit in this mounting position, check if the built-in unit has to meet the requirement for a fire protection enclosure in the desired operating area. If in doubt, install the built-in unit in an enclosure that is compliant with the requirements of sections 4.6 and 4.7.3 of the IEC/UL/EN/DIN-EN 60950-1 standard.</p> <p>DVD operation not permitted</p> <p>Operation of the DVD drive is not permitted in the "Upright mounting in vertical position" mounting position.</p>

Display rotated 90° vertical from the standard position. The power supply is located at the top.

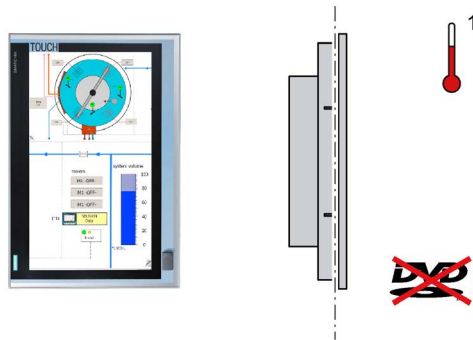

¹ For temperature specifications, see section "Environmental conditions (Page 149)".

3.1.3.2 Preparing the mounting cutout

Note

Stability of the mounting cutout

The material in the area of the mounting cutout must provide sufficient strength to guarantee the enduring and safe mounting of the HMI device.

The force of the clamps or operation of the device may not lead to deformation of the material in order to achieve the degrees of protection described below.

Note

Read the information in the section "Installation guidelines (Page 43)".

3.1 Preparing for mounting

Requirements for complying with degree of protection

The degree of protection of the HMI device can only be guaranteed if the following requirements are met:

- Material thickness at the mounting cutout with IP65 degree of protection or Enclosure Type 4X / 12 (indoor use only): 2 mm to 6 mm
- Permitted deviation from plane at the mounting cutout: ≤ 0.5 mm
This condition must be fulfilled for the mounted HMI device.
- Permissible surface roughness in the area of the mounting seal: $\leq 120 \mu\text{m}$ ($R_z 120$)

Dimensions of the mounting cutout

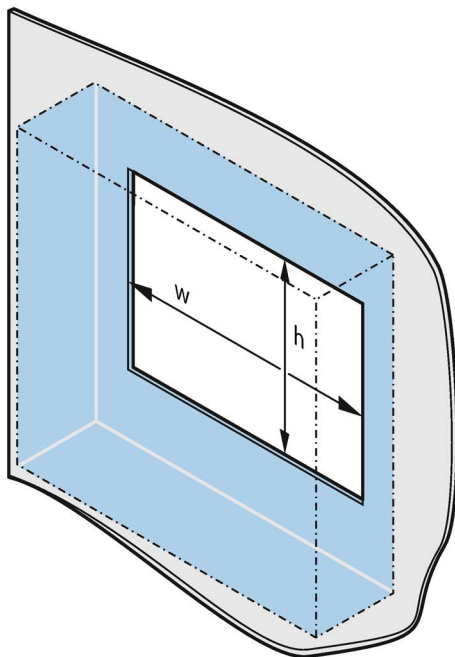

Mounting cutout of touch devices

Mounting cutout	Device					
	12" ³	15.6" ²	15" ³	19" ^{2 3}	22" ^{2 3}	15" ⁴
Width w ¹	310 mm	399 mm	396 mm	465 mm	542 mm	450 mm
Height h ¹	221 mm	280 mm	291 mm	319 mm	362 mm	290 mm

- ¹ Width and height must be interchanged for mounting in vertical format.
- ² Device with capacitive multi-touch screen
- ³ Device with resistive single-touch screen
- ⁴ Touch/key device

Installation depth

Information on the overall depth is available in the section "Dimension drawings (Page 135)".

3.1.3.3 Labeling the function keys

Use labeling strips for project-related labeling of the function keys of your device.

You will find labeling strip templates with a scale of 1:1 as a Word file:

- On the Internet at:

Labeling strips for 15" widescreen

(<http://support.automation.siemens.com/DE/view/en/59000814>)

If you would like to make your own labeling strips, you can find the dimensions under "Dimension drawing of labeling strips (Page 144)".

Note

Do not write on the keyboard to label the function keys.

Any printable and writable film can be used as labeling strip. The permitted thickness of the labeling strip is 0.15 mm. Do not use paper labeling strips.

Requirements

- The device is installed
- Template for labeling strips is available

Procedure

1. Edit the template on a PC and then print it.
2. Apply a fixation spray film to the labeling strips.
The printout can be made water and smudge-proof with a fixation spray. The color printer ink will not bleed onto the keyboard film as well.
3. Cut out the labeling strip.
4. Cut the corners at a 45° angle so that it is easier to slide the strip into the slot.
5. When the ink has dried, slide all but the last 3 cm of the labeling strip into the guide.

3.1 Preparing for mounting

The following figure shows the positions of the device openings for each labeling strip.



- ① Guide for labeling strips F1, F3 ... F15
- ② Guide for labeling strips F2, F4 ... F16
- ③ Guide for labeling strips F17 ... F22
- ④ Guide for labeling strips F23 ... F26
- ⑤ Guide for labeling strips F27 ... F31
- ⑥ Guide for labeling strips F32 ... F36

Result

The labeling strips protrude approximately 3 cm out of the slot. The template dimensions for the labeling strips are designed so that the labeling is correctly placed for the function keys. It is not necessary to secure the labeling strip.

When mounting the HMI device, make sure that the labeling strips do not get jammed between the mounting cutout and the HMI device.

3.1.4 PRO device

3.1.4.1 Permitted mounting positions

Mounting position

The mounting positions described below are permitted for the PRO device.

- Standard mounting position: Vertical installation in horizontal format
- Inclined installation in horizontal format with a vertical inclination of maximum $\pm 45^\circ$

Upright mounting in vertical format is prohibited for the PRO device

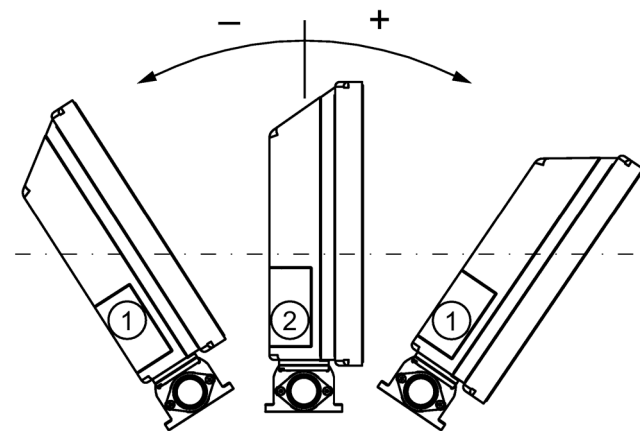



	Mounting position	Deviation from the vertical
①	Inclined	$\leq 45^\circ$
②	Vertical	0°

3.2 Installing the built-in unit

3.2.1 Installation guidelines

 WARNING
<p>Danger, high voltage</p> <p>A high voltage may be present in the control cabinet and could cause a dangerous electric shock.</p> <p>It may result in death or serious physical injury.</p> <p>Isolate the power supply to the control cabinet before opening it. Ensure that the power to the control cabinet cannot be turned on accidentally.</p>

 WARNING
Risk of fire If you install the device in an unapproved mounting position or if you do not observe the ambient conditions, the device can overheat. Overheating can cause a fire. Proper functioning of the device is no longer guaranteed. Before you install the device, note the following general installation information.

 WARNING
Requirements for a fire protection enclosure according to EN 60950-1 only for standard mounting position In the standard mounting position and in the inclined position in horizontal format with vertical inclination of max. $\pm 45^\circ$, the device meets the requirements for fire protection enclosures in accordance with EN 60950-1. It can therefore be installed without an additional fire protection cover. For information on the mounting positions, refer to section "Permitted mounting positions (Page 38)".

- Install the device only in one of the permitted mounting positions.
- For installation in control cabinets, note the SIMATIC setup guidelines as well as the relevant DIN/VDE requirements or the country-specific regulations.
- Ensure that the device is classified as "Open Type" when using it in the area of Industrial Control Equipment (UL508). A UL508 conform enclosure is therefore a mandatory requirement for approval or operation according to UL508.
- Provide adequate volume in the control cabinet for air circulation and heat transport. Keep at least 5 cm distance between the device and control cabinet.
- The ventilation slots of the device may not be covered or obstructed.
- Ensure there is enough clearance in the control cabinet to allow the backplane cover to be removed.
- Equip the control cabinet with struts for stabilizing the mounting cut-out. Install struts where necessary.

See also

Technical specifications (Page 145), Dimension drawings (Page 135)

3.2.2 Mounting clips or mounting brackets, position for IP65-compliant installation

Types of mounting clips and mounting brackets

You can mount the device as follows:

- Device with 12" display:

With 12 mounting clips (aluminum), included in the product package



- Device with 15", 19" or 22" display:

With 12 mounting clips, steel (included in the product package)

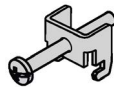

- Device with 15", 19" or 22" display:

With 6 mounting brackets (available as accessories)

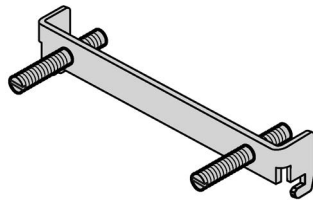

Positions of the mounting clips or mounting brackets for IP65

To achieve IP65 degree of protection for the device, the mounting clips or mounting brackets must be installed at the positions shown below.

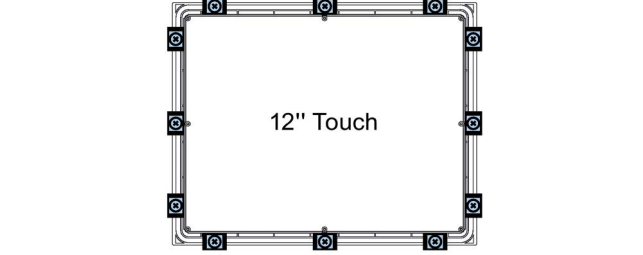
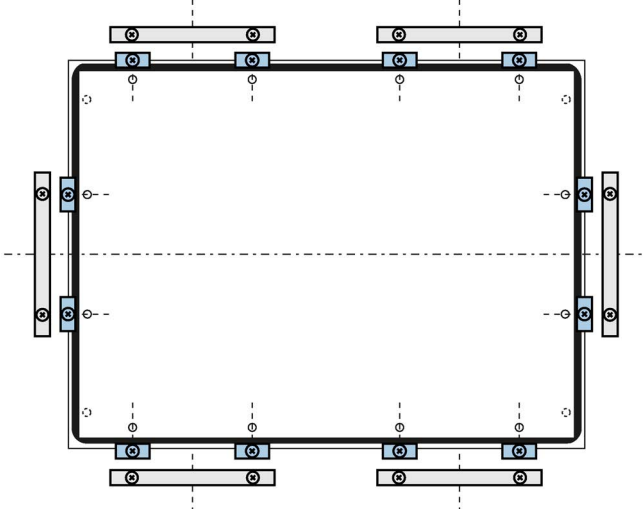
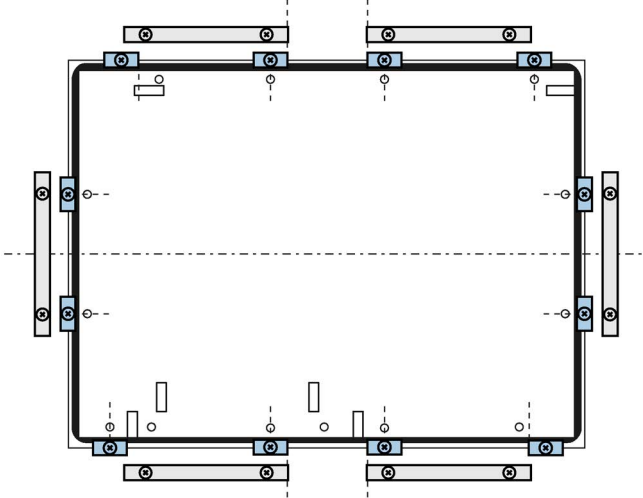
Device	Position
Touch screen device with: <ul style="list-style-type: none"> • 12" display (mounting clips only) 	
Touch screen device with: <ul style="list-style-type: none"> • 15" display • 19" display • 22" display 	
Touch/key device with: <ul style="list-style-type: none"> • 15" display 	

3.2.3 Mounting the device with mounting clips

Positions of the mounting clips

To achieve the degree of protection for the device, the positions for the mounting clips shown below must be adhered to.

The positions of the mounting clips are marked by stamps on the cutouts. Fit the mounting clips in all the stamped cutouts.

Requirement

- All packaging components and protective films have been removed from the device.
- To install the device, you need the mounting clips from the accessory kit.
- The mounting seal on the front of the device is not managed.

Procedure

Note

If the mounting seal is damaged or protrudes from the device, the guaranteed degree of protection is not ensured.

It is prohibited from mounting the device if the mounting seal is damaged.

3.2 Installing the built-in unit

1. Working from the front, insert the device into the mounting cut-out. Secure the device to prevent it from falling out.
2. Insert a mounting clip into the cutout provided on the device. Make sure it is in the correct position, see the section "Mounting clips or mounting brackets, position for IP65-compliant installation (Page 45)".
3. Tighten the threaded pin to secure the mounting clip. The maximum torque when tightening the threaded pins of the mounting clips is 0.5 Nm.
4. Repeat steps 2 and 3 for all mounting clips.

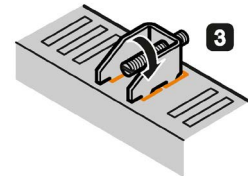
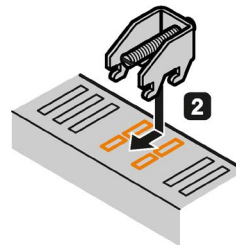
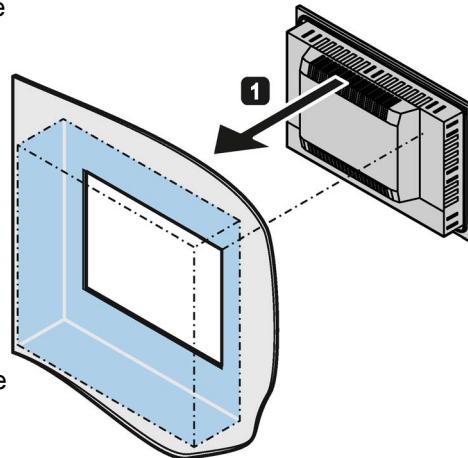

Mounting clips for devices with 12" display

5. Check the fit of the mounting seal.

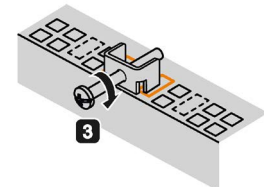
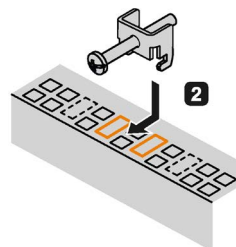

Mounting clips for 15", 19" or 22" display

3.2.4 Mounting the device with mounting brackets

If there are strict requirements for the front seal, it may be necessary to fasten the device with mounting brackets in a cabinet. You can secure each device with 6 mounting brackets.

The mounting brackets are available as accessories. You can find ordering information in the section Accessories (Page 25).

Requirement

- All packaging components and protective films have been removed from the device.
- The accessory mounting brackets are available.
- 2.5 mm hexagonal spanner

Procedure

Note

If the mounting seal is damaged or protrudes over the device, the degree of protection is not guaranteed.

1. Working from the front, insert the device into the mounting cut-out.

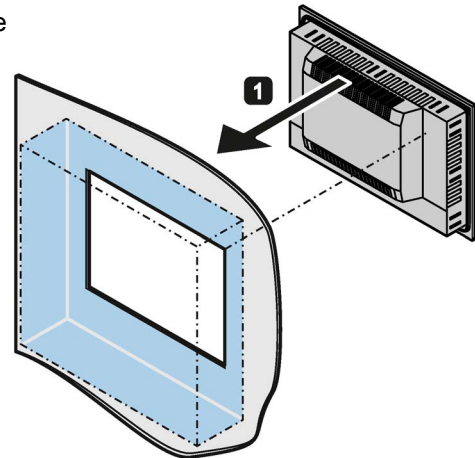

2. Insert the mounting clamp into the recesses on the device. Make sure it is in the correct position, see the section "Mounting clips or mounting brackets, position for IP65-compliant installation (Page 45)".

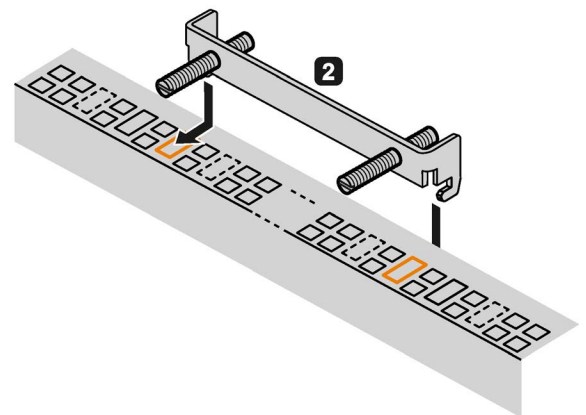

3. Secure the mounting bracket by tightening the threaded pins. The maximum permissible torque is 0.5 Nm.

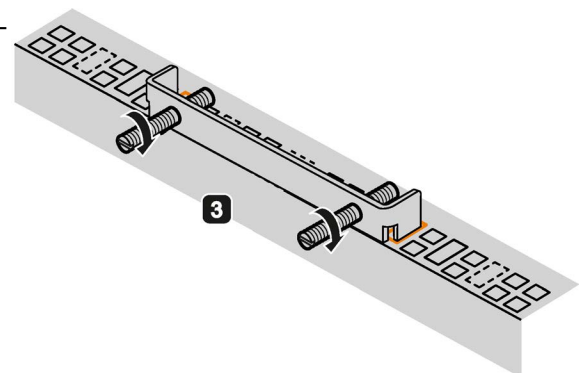

4. Repeat steps 2 and 3 until all mounting brackets are attached.
5. Check the fit of the mounting seal.

IP65 degree of protection

The installer of the plant is responsible for proper installation of the device.

 WARNING
<p>Risk of electric shock</p> <p>The degree of protection cannot be guaranteed if the device is not correctly installed. Moisture or water can penetrate and cause electric shock or plant damage.</p> <p>The IP65 degree of protection is ensured for the front of the device only if you observe the following:</p> <ul style="list-style-type: none"> • Installation with mounting clamps • The circumferential seal is properly attached to a correctly sized cutout. • Follow the instructions when measuring the dimensions as shown in the section "Preparing the mounting cutout (Page 39)".

3.2.5 Position of the mounting clips for IP66-complaint installation

Positions of the mounting clips

To achieve IP66 degree of protection instead of IP65 for a device with capacitive multi-touch screen, fasten 4 additional mounting clips (available as accessories) at the positions marked by the red boxes. The 15" display meets IP66 even without additional mounting clips.

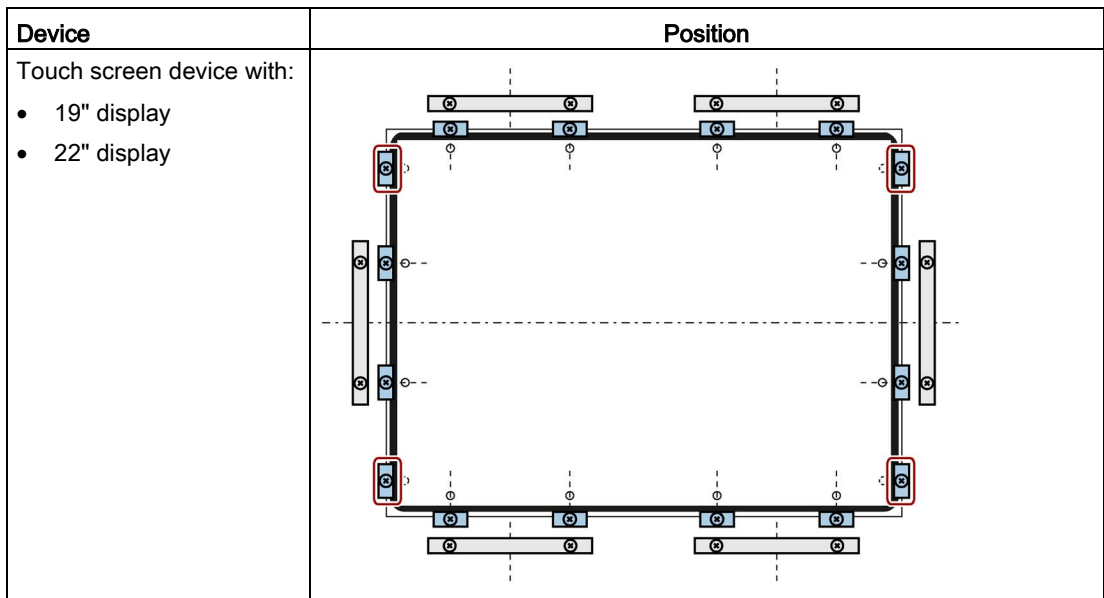

3.3 Mounting the PRO device

Requirement

- All packaging components and protective films have been removed.
- Siemens base adapter with screws

Note

Mounting without base adapter

If you install the device without a base adapter, you must adjust the mechanical interface between the support arm or stand and the unit accordingly, including placement of an appropriate seal on the mechanical interface of the device.

- A support arm or stand system from a third party (see section "Accessories (Page 25)") including a support arm or stand head (see ① figure below) and a proprietary adapter set:
 - Intermediate plate (see ② figure below) with screws
 - or
 - Coupling with screws without intermediate plate

NOTICE
Degree of protection for overall device
If you are using a support arm system or a stand system that does not have IP65 degree of protection or Enclosure Type 4X / 12 (indoor use only), IP65 degree of protection and Enclosure Type 4X / 12 (indoor use only) are lost for the entire device. Spray and water jets as well as penetrating substances can then damage the device. Only use a support arm system or stand system that has IP65 degree of protection and Enclosure Type 4X / 12 (indoor use only).

- The following cables are fed through the stand or the support arm to which the device is mounted:
 - Protective conductor
 - Power supply cable
 - Data cables, e.g. USB

For even large connectors to fit, run their cables through the stand or support arm first, for example, DVI or PROFIBUS.

Procedure

This section describes the mounting on a support arm system. Mounting on a stand is analogous. With the "Device for support arm system" ordering option, the base adapter is screwed onto the top of the device, with the "Device for stand" ordering option it is installed below. A device for a support arm system cannot be used on a stand, and vice versa.

WARNING

The device must be mounted securely.

Inadequately dimensioned fasteners may cause the device to fall down. Serious bodily injury may result.

Make sure that fasteners are adequately dimensioned during installation of the device. Make sure to consider the weight of the device and the forces acting on the device when dimensioning the fasteners. This applies in particular to dynamic load of the device. All fasteners including mounting surfaces, support arm systems, and fastening elements such as screws, must be able to carry at least four times the weight of the device.

Observe any further statutory specifications applying at the location of use of the device and further applicable regulations with regard to fastening of the device.

Note

Disclaimer of liability

The device is mounted to a stand or a support arm via the mechanical interface with screws. Siemens AG assumes no liability for the consequences of incorrect installation.

Warranty at risk

If you do not install the HMI device in accordance with the specifications in these operating instructions, the warranty for the device becomes void.

- Always install the device according to these operating instructions.
- If the seal is damaged, it must be repaired. In case of a repair, follow the procedure described in the section Repair information (Page 109).

IP65 degree of protection and Enclosure Type 4X / 12 (indoor use only) at risk

If there are no seals on the adapters or these are damaged, IP65 degree of protection and Enclosure Type 4X / 12 (indoor use only) are at risk. Check the condition and proper seating of the seals.

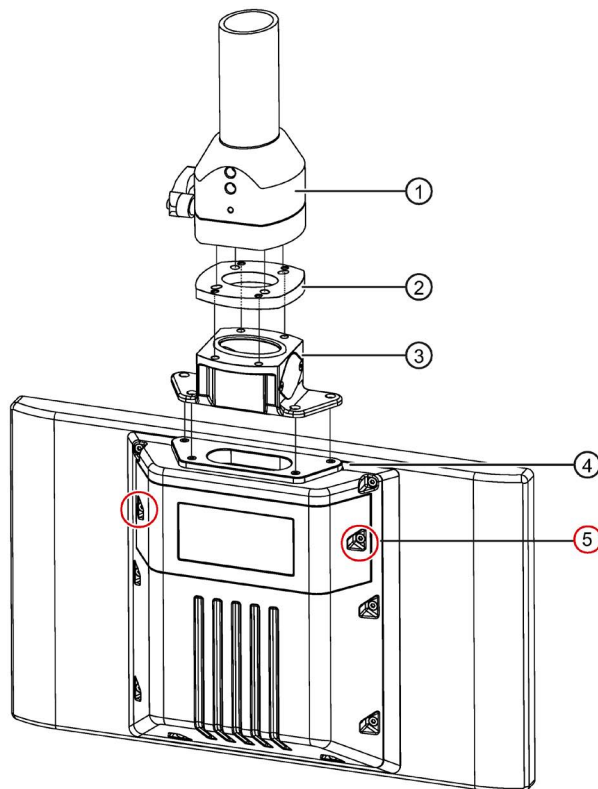
**NOTICE****Damaging the seal when opening**

If the device has not been opened for a long time, the backplane cover and terminal compartment cover may stick to the enclosure caused by the seal. Opening the device with excessive force or with tools will destroy the seal. Spray and water jets as well as penetrating substances can then damage the device.

Open the terminal compartment cover gently, without too much pressure.

NOTICE**Observe the torques**

If you use **too much** torque to tighten the screws of the backplane cover and the terminal compartment cover or the screws for fastening the device to a support arm or stand, the threads of the enclosure, intermediate plate or support arm may be damaged. If you tighten the screws with a torque that is **too low**, the device is not sealed.

Tighten the screws with the following torques, which may not be exceeded:

Adhere to the torque specifications of the third-party vendors:

- Intermediate plate ② - Support arm head ①
- Base adapter ③ - Intermediate plate ②
- Base adapter ③ to coupling on support arm ①

2.5 Nm for the following connection:

- Countersunk head screw device ④ - Base adapter ③

1.5 Nm for the following connections:

- Terminal compartment cover ⑤ - device
- Backplane cover - device

3.4 Connecting the device

1. Remove the screws ⑤ of the terminal compartment cover.
2. Open the terminal compartment cover and set it aside safely.
3. If there is an intermediate plate in the adapter set: Fasten the intermediate plate ② to the support arm head ① from the bottom with four M6 x 12 screws from the adapter set. Check that the seal is properly seated.
4. If there is an intermediate plate in the adapter set: Fasten the base adapter ③ to the intermediate plate ② from below using the four M6 x 12 screws from the adapter set. Check that the seal is properly seated.
5. If there is **no** intermediate plate in the adapter set: Fasten the base adapter ③ to the coupling of the support arm head ① from below using the four screws from the adapter set.
6. Fasten the device ④ to the base adapter ③ from the top with four M4 x 12 countersunk head screws from the Siemens base adapter set. Make sure that all connecting cables are fed through the adapter into the interior of the device without damage.
7. Connect the device.
8. If you connect the device at a later time, fasten the terminal compartment cover to the device.

3.4 Connecting the device

3.4.1 Notes on connecting

 WARNING
Risk of fire and electric shock
The on/off switch does not isolate the device from the power supply. Risk of electric shock if the device is opened incorrectly or defective. There is also a risk of fire if the device or connecting lines are damaged.
You should therefore protect the device as follows:
<ul style="list-style-type: none">• Always pull out the power plug when you are not using the device or if the device is defective. The power plug must be freely accessible.• Connect the device to a protective conductor as instructed, see section "Connecting the protective conductor".• Use a central isolating switch in the case of cabinet installation.

⚠ WARNING**Risk of lightning strikes**

A lightning flash may enter the mains cables and data transmission cables and jump to a person.

Death, serious injury and burns can be caused by lightning.

Take the following precautions:

- Disconnect the device from the power supply in good time when a thunderstorm is approaching.
- Do not touch mains cables and data transmission cables during a thunderstorm.
- Keep a sufficient distance from electric cables, distributors, systems, etc.

NOTICE**Fault caused by I/O devices**

The connection of I/O devices can cause faults in the device.

The result may be personal injury and damage to the machine or plant.

Note the following when connecting I/O devices:

- Read the documentation of the I/O devices. Follow all instructions in the documentation.
- Only connect I/O devices which are approved for industrial applications in accordance with EN 61000-6-2 and IEC 61000-6-2.
- I/O devices that are not hotplug-capable may only be connected after the device has been disconnected from the power supply.

NOTICE**Damage through regenerative feedback**

Regenerative feedback of voltage to ground by a connected or installed component can damage the device.

Connected or built-in I/Os, for example, a USB drive, are not permitted to supply any voltage to the device. Regenerative feedback is generally not permitted.

3.4.2 Power supply built-in unit

3.4.2.1 Connecting the protective earth

A connected protective conductor conducts dangerous electrical charges away from the metal enclosure. The current flowing through the protective conductor when such a fault occurs triggers a primary fuse that disconnects the device from the power supply.

The protective conductor also improves the discharge of interference generated by external power cables, signal cables or cables for I/O devices to ground.

The connection for the protective conductor is labeled with the following symbol:



 WARNING
Electric shock and risk of fire
High voltage may be present in a defective device, which can cause fire or an electric shock if touched. Death and serious bodily injury can result.
<ul style="list-style-type: none">• Connect the device to the protective conductor before you put it into operation.• The protective conductor connection on the device must be connected to the protective conductor of the control cabinet or system in which the device is installed.• Never operate the device without protective conductor.• If a device is defective, decommission it without delay and mark it accordingly.

Requirement

- The device is installed
- 1 protective conductor
 - 1 protective conductor with minimum core cross-section of 2.5 mm²
- 1 T20 screwdriver
- 1 cable lug for M4

Procedure

Connection of the protective conductor is described using the example of the 12" display.

1. Clamp the cable lug onto the protective conductor.
2. Connect the cable lug to the screw at the designated protective conductor connection.

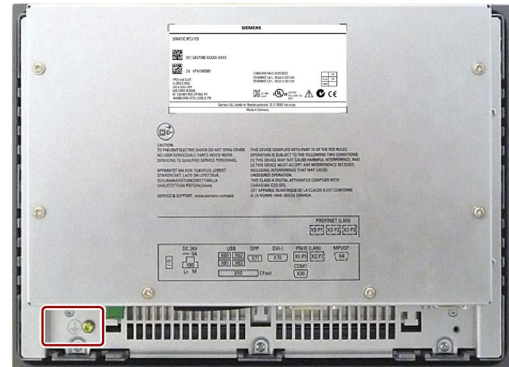

3. Connect the protective conductor to the protective conductor connection of the control cabinet in which the device is installed.

3.4.2.2 Connect 100-240 VAC power supply

The following procedure applies to a device that is connected to a 100 VAC - 240 VAC (-15 % / +20 %) power supply system, 50 - 60 Hz. The power consumption at 240 V can be up to 90 W, depending on device.

General connection information

Note the following in order to operate the device safely and according to regulation:

Note

The wide-range power supply is designed for 100 to 240 VAC power supply systems. It is not necessary to adjust the voltage range. The permitted nominal voltage of the device must conform with local mains voltage.

Note

Do not connect or disconnect power and data cables during thunderstorms.

 WARNING
Power supply system
<p>The device is intended for operation on grounded power supply systems (TN systems according to VDE 0100, Part 300, or IEC 60364-3).</p> <p>It is not designed for operation on ungrounded or impedance-grounded power networks (IT networks).</p>

Note

Power disconnection

The power plug must be unplugged to fully isolate the device from mains. This location must be easy to access. There must be a central disconnect switch if the device is mounted in a control cabinet.

Always ensure that the socket on the device is freely accessible or that the grounding-type receptacle of the building installation is freely accessible and located as close as possible to the device.

Note

The power supply contains an active PFC (Power Factor Correction) circuit to conform to the EMC guidelines.

Uninterruptible AC power supplies (UPS) must supply a sinusoidal output voltage in the normal and buffered mode when used with SIMATIC IPCs with an active PFC.

UPS characteristics are described and classified in the standards EN 50091-3 and IEC 62040-3. Devices with sinusoidal output voltage in the normal and buffered mode are identified with the classification "VFI-SS-...." or "VI-SS-....".

Country-specific connection information

USA and Canada

For the United States and Canada, a CSA or UL-listed power supply cord must be used. The connector must conform to NEMA 5-15.

Country-specific power supply cords are available as accessories.

- **100 V supply voltage**
Use a flexible cable with UL approval and CSA mark and the following features:
 - Type SJT with three conductors
 - Conductor cross-section at least 18 AWG, ≤ 4.5 m in length
 - Parallel grounding-type plug 15 A, at least 125 V
- **240 V supply voltage**
Use a flexible cable with UL approval and CSA mark and the following features:
 - Type SJT with three conductors
 - Conductor cross-section at least 18 AWG, ≤ 4.5 m in length
 - Tandem grounding-type plug 15 A, at least 250 V

For countries other than the USA and Canada:

- **240 V supply voltage**
This device is equipped with a safety-tested power supply cord and may only be connected to a grounded power outlet. If this power cord is not used, a flexible cable with a conductor cross-section of at least 18 AWG must be used. The set of cables must conform to the safety regulations of the country in which the device is installed and bear the marks required in each case.

Requirement

- The device is installed.
- The protective conductor is connected, see the section "Connecting the protective earth (Page 56)".

Procedure

Connecting the power supply cord

1. Set the switch to the "Off" position, as shown.



2. Remove the two marked screws of the mains plug fastener.

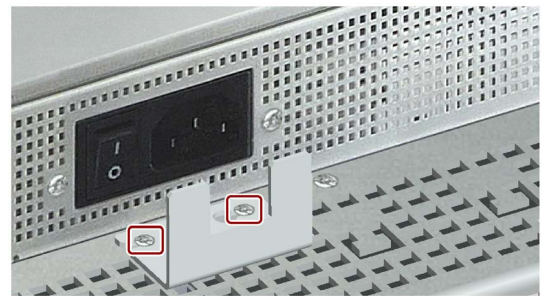

3. Insert the power cable into the socket and fasten the power plug fastener with the marked screws.

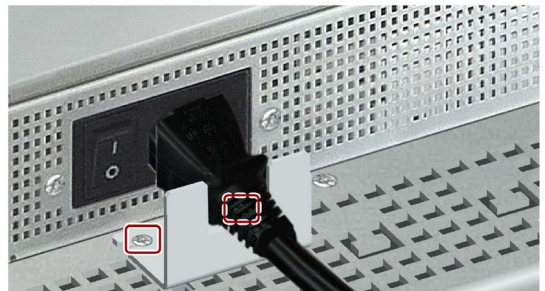

Unplugging the power supply cord

 WARNING
Risk of electric shock The on/off switch does not disconnect the device from the power supply system. Always unplug the power plug to disconnect the device from the power supply system.

Perform the steps for connecting the power supply cord in reverse order.

3.4.2.3 Connecting the terminal

The connection terminal for connecting the power supply is fitted to the device. The connection terminal is designed for cores with a cross-section of between 0.25 mm² and 2.5 mm². Only connect cores with a cross-section of ≥ 0.5 mm².

You can use either semi-rigid or flexible cables. You do not need to use end sleeves.

Requirements

- 1 connection terminal
- 1 0.5 x 3 Philips screwdriver

Procedure

NOTICE

Damage to the device

Do not adjust the screws in the connection terminal when it is plugged into the device. The pressure of the screwdriver on the connection terminal and the socket can damage the device.

Connect the wires to the connection terminal when it is not plugged in.

Note

Make sure that the cores are connected to the correct terminals. Observe the labeling for the contacts on the front cover of the device.

1. Connect the lines as shown. Make sure the connection terminal is in the correct position as shown.

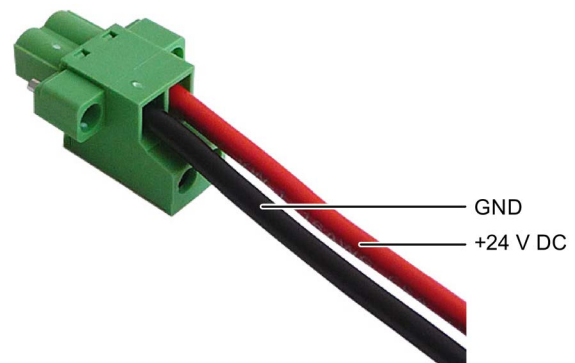

3.4.2.4 Connecting the 24 V DC power supply

Please note the following:

WARNING

Electric shock and risk of fire

Voltages that exceed an extra-low voltage can cause electric shock or fire. Death or serious bodily injury can result.

- The device may only be connected to a 24 V DC power supply that meets the requirements of a safe extra-low voltage (SELV) according to IEC/EN/DIN EN/UL 60950-1.
- The supplying source must be fused for a power rating $< 240 \text{ VA}$; recommended fuse rating $\leq 8 \text{ A}$.

Note

The 24 VDC power supply must be adapted to the input data of the device (see the technical specifications in the operating instructions).

Requirement

- The device is installed.
- The protective conductor is connected.
- The connection terminal is wired.
- The corresponding 24 V DC power supply is switched off.

Procedure

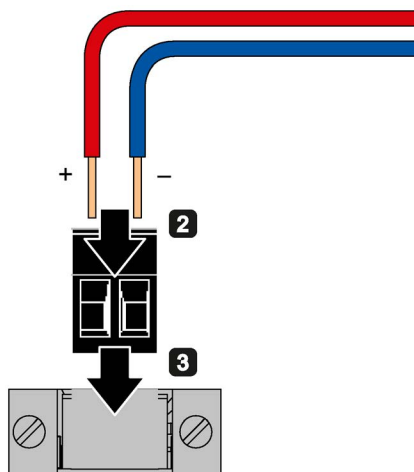

- 1** Switch off the 24 VDC power supply.
- 2** Connect the wires of the power supply.

3.4 Connecting the device

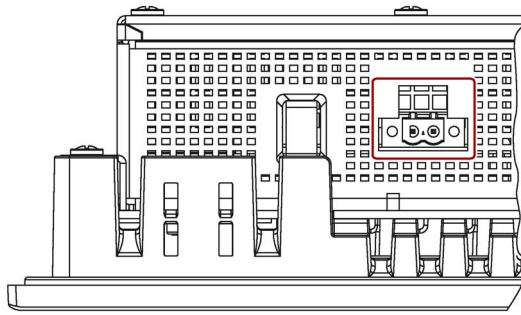

3 Connect the connection terminal at the marked position.

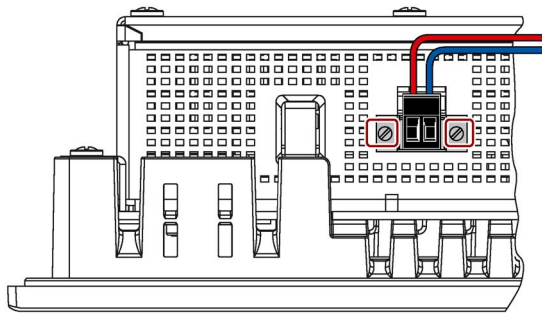

4 Secure the connection terminal with the marked screws.

3.4.3 Power supply PRO device

3.4.3.1 Opening and closing the terminal compartment cover

Requirement

- The device is disconnected from the power supply.
- Torx TX20 screwdriver

Opening the terminal compartment cover



①

1. Loosen the indicated M4x16 screws.

NOTICE**Damaging the seal when opening**

If the device has not been opened for a long time, the backplane cover and terminal compartment cover may stick to the enclosure caused by the seal. Opening the device with excessive force or with tools will destroy the seal. Spray and water jets as well as penetrating substances can then damage the device.

Open the terminal compartment cover gently, without too much pressure.

2. Carefully lift up the terminal compartment cover and set it aside.
The assignment of the interfaces is shown on the inside of the terminal compartment cover.
3. Run the cable through the support arm or stand from the bottom ① into the PRO device and connect it to the interfaces on the inside.

Closing the terminal compartment cover

1. Check that the seal is properly seated on the terminal compartment cover.

Note**IP65 degree of protection at risk**

If the seal on the terminal compartment cover is damaged, IP65 degree of protection is at risk. The device must be repaired. Proceed as described in the section Repair information (Page 109).

2. Place the terminal compartment cover on the backplane cover. Make sure that no cables are crimped.

Secure the terminal compartment cover from falling down.

Note**Do not exceed the permissible torque**

When you tighten up the M4x16 screws with a torque of > 1.5 Nm, you may damage the threading in the enclosure.

3. Tighten the M4x16 screws of the terminal compartment cover using a maximum torque of 1.5 Nm.

3.4.3.2 Connecting the PE conductor of the PRO device

The connection for the protective earth is labeled with the following symbol:



Requirement

- The device is installed.
- 1 protective conductor
 - 1 protective conductor with minimum core cross-section of 2.5 mm²
- 1 T20 screwdriver
- 1 cable lug for M4

Procedure

1. Clamp the cable lug onto the protective conductor.
2. Connect the cable lug to the screw at the designated protective conductor connection.

Tighten the M4 screw with a torque of max. 1.5 Nm.



3. Connect the protective conductor to the protective conductor connection of the control cabinet from which the PRO device is supplied.

3.4.3.3 Connecting the 24 V DC power supply PRO device

⚠ WARNING

Electric shock and risk of fire

Voltages that exceed an extra-low voltage can cause electric shock or fire. Death or serious bodily injury can result.

- The device may only be connected to a 24 V DC power supply (-20 % / +20 %) that meets the requirements of a safe extra-low voltage (SELV) according to IEC/EN/DIN EN/UL 60950-1.
- The power supply must meet the requirement NEC Class 2 or LPS according to the IEC/EN/DIN EN/UL 60950-1.

Note

The 24 V DC power supply must be adapted to the input data of the device (see technical specifications).

Requirement

- The device is installed.
- The protective conductor is connected.
- The connection terminal is wired.
- The corresponding 24 VDC power supply is switched off.

Procedure

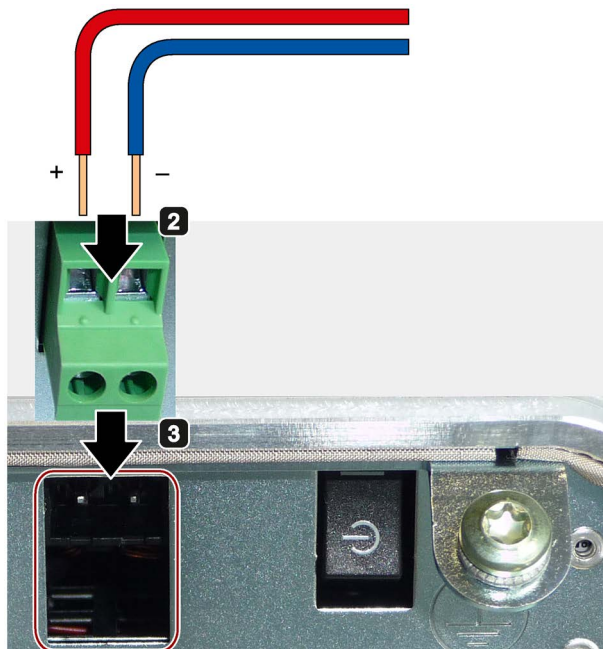

- 1** Switch off the 24 V DC power supply.
- 2** Connect the wires of the power supply.
- 3** Plug the connecting terminal into the connection socket at the indicated position.
The connecting terminal must snap into the connection socket.
- 4** Secure the power supply cable to the strain relief with a cable tie.

3.4.4 Connecting peripheral equipment

Note

Ensure suitability for industrial applications

Connect only I/O devices approved for industrial applications according to EN IEC 61000-6-2.

Note

Peripheral devices capable of hot-plugging (USB)

Hot-plug I/O modules (USB) may be connected while the IPC is in operation.

NOTICE

Peripheral devices incapable of hot-plugging

Peripheral devices that are incapable of hot-plugging may only be connected after the device has been disconnected from the power supply. Strictly adhere to the specifications for peripheral equipment.

Note

Wait at least ten seconds between removing and reinserting USB devices.

When using standard USB devices, bear in mind that their EMC immunity level is frequently designed only for office environments. These USB devices are adequate for commissioning and servicing purposes. Only industrial grade USB devices are permitted for use in industrial environments. The USB devices are developed and marketed by the respective provider. The product supplier in each case provides support for the USB devices. Moreover, the terms of liability of the individual vendors or suppliers apply here.

Note

Strain relief

Use the metal eyelets on the rear side to mount the cable strain reliefs for cable ties.

3.4.5 Connecting the device to networks

The following options are available for integrating the device in existing or planned system environments and networks.

Ethernet

You can use the integrated Ethernet interfaces (10/100/1000 Mbps) for communication and data exchange with automation devices, e.g. SIMATIC S7.

You need a suitable software to use this functionality: STEP 7, WinCC, WinAC, SIMATIC NET.

Industrial Ethernet

You can establish a network between the device and other computers via Industrial Ethernet. The on-board LAN interfaces are twisted-pair TP interfaces that support data transmission rates of 10/100/1000 Mbps.

Note

You need a category 6 Ethernet cable for operation at 1000 Mbps.

PROFINET

PROFINET can be operated via:

- Standard Ethernet interfaces (RT)

PROFIBUS/MPI

The isolated PROFIBUS interface can be used to connect distributed field devices or to link them with SIMATIC S7. You will need STEP 7, WinCC, WinCC flexible, WinAC and SIMATIC NET.

Note

Special connector for PRO device

Due to space constraints, only use the compact PROFIBUS connector with the following article number for the PRO device: 6GK1500-0FC10.

SIMATIC NET

Use this software package to create, operate and configure an innovative network for Field & Control level. Information on this can be found on the SIMATIC NET Manual Collection CD. The software package and the documentation are not included in the product package.

Additional information

You can find additional information on the Internet at: Technical Support (http://www.siemens.de/automation/csi_en_WW)

3.4.6 PROFINET

CP 1616 onboard

The basic characteristics of the PCS 1616 onboard are:

- Optimized for PROFINET IO
- With Ethernet realtime ASIC ERTEC 400
- Three RJ45 sockets for connection terminal devices or addition network components
- Integrated 3-port real-time switch
- Automatic hardware detection

NOTICE
A maximum of one CP 1616/1604 is permitted
A maximum of one CP 1616/1604 module can be installed in one PG/PC. If you want to use an additional CP 1616/1604 card, the CP 1616 onboard option must be disabled using the "Profinet" entry in the BIOS setup.

Additional documentation on PROFINET

Get an overview of the information available for PROFINET (<http://support.automation.siemens.com/WW/view/en/18880715/133300>).

Document name	What is contained in this document?
This documentation is not included in the product package:	
Getting Started PROFINET IO Getting Started: Manual Collection	The documents use concrete examples to provide step-by-step instructions on how to commission a fully functional application.
Manual PROFINET System Description	This gives you the basic knowledge about the PROFINET IO topics: Network components, data exchange and communication, PROFINET IO, component-based automation, application example of PROFINET IO and component-based automation.
Manual From PROFIBUS DP to PROFINET IO	Read this document if you want to convert an installed PROFIBUS system to a PROFINET system.
Readme file for CP 1616/CP 1604 and DK-16xx PN IO	This provides the latest information about the SIMATIC NET products CP 1616/CP 1604, CP 1616 onboard, the developer kit.
Configuration Manual Commissioning PC Stations	This provides you will all the information necessary for commissioning and configuring a PC as a PROFINET IO controller or IO device.

Document name	What is contained in this document?
Manual SIMATIC NET Industrial Communication with PG/PC: Volume 1 - Basics SIMATIC NET Industrial Communication with PG/PC: Volume 2 - Interfaces	This manual introduces you to industrial communication and explains the available communication protocols. It also describes the OPC interface as an alternative to the IO-based user programming interface.
S7 CPs for Industrial Ethernet Configuring and Commissioning	This provides the following support: - For commissioning S7 stations - For establishing effective communication
Manual SIMATIC NET - Twisted Pair and Fiber-Optic Networks	Configure and build your Industrial Ethernet networks based on this document.
This documentation is part of the supplied Documentation and Drivers CD:	
Operating instructions CP 1616/CP 1604/CP 1616 onboard	This provides you with all information required for operation.
Installation guide Device Driver CP16xx.sys	Read this guide if you want to install the NDIS device driver, CP16xx.sys.

Further information

You can find the information on specific products in the Internet at the address: Product-related Information SIMATIC NET (<http://www.siemens.com/simatic-net>)

3.4.7 Securing cables on the built-in unit

On the rear panel of the device are attachment eyelets for cable ties used for strain relief of the following cables:

- 24 VDC power supply cable
- RS-232 cable
- USB cable

The following figure shows the position of the attachment eyelets for each cable tie using the IPC477D 12" display as an example. The position of the attachment eyelets is the same for all device variants.

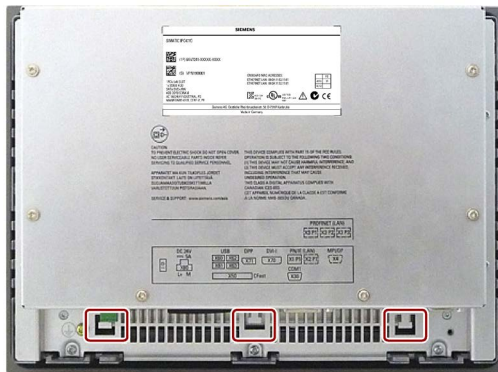

Requirement

- The device is installed.
- The device is connected.

Procedure

Attach all cables that cannot be secured with the strain relief according to section "Attaching PROFINET strain relief (Page 71)" to one attachment eyelet.

1. Secure the connecting cable to the nearest attachment eyelet with a cable tie.
2. Cut off the protruding cable tie tongue.

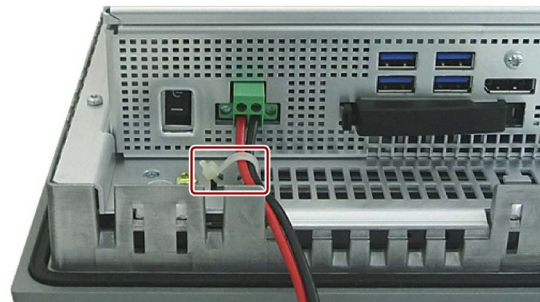

3.4.7.1 Attaching PROFINET strain relief

The strain relief for PROFINET connectors prevents unintentional disconnection of the connectors from the device. The strain relief and the fasteners required for it are included in the product package.

Requirement

- The device is installed
- 1 strain relief
- 2 screws
- Cable ties
- 1 T10 screwdriver

Procedure

Attaching the strain relief is described using the example of the 12" display. The procedure is the same for all device variants.

Attaching

1. Screw on the strain relief with a screw at the marked positions.

In the figure, one screw is hidden by the strain relief.

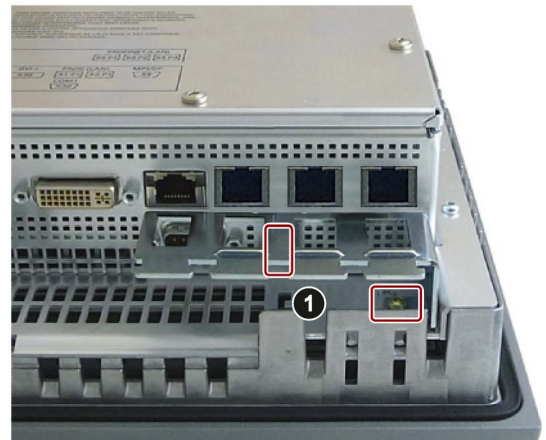

2. Clip on the connector.
3. Secure each connector with a cable tie.

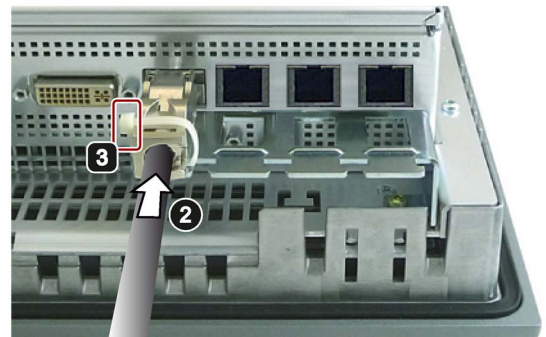

Remove

Perform the steps for attaching the strain relief in reverse order.

Commissioning the device

4.1 General information on commissioning

 CAUTION
<p>Danger of burns</p> <p>The surface of the device can reach temperatures of over 70 °C. Any unprotected contact may cause burns.</p> <p>Avoid direct contact with the device while it is in operation. Touch the device only with appropriate protective gloves.</p>

Note

Windows Embedded Standard 7 - Note the EWF and FBWF information

Two configurable write filters (Enhanced Write Filter and File Based Write Filter) are provided with Windows Embedded Standard. Read the EWF/FBWF information if you activate and use them, otherwise you may experience data loss.

- Enhanced Write Filter (Page 88)
- File Based Write Filter (FBWF) (Page 90)

Note

Configuring memory cards in the device

Memory cards used in a device need to be configured on that device. Memory cards configured on other devices will not boot as the drive parameters will be different.

Requirement

- The terminal compartment cover of the PRO device is open.
- The device is connected to the power supply.
- The protective conductor is connected.
- The connection cables are plugged in correctly.
- The following hardware is available for initial commissioning:
 - One USB keyboard
 - One USB mouse

Note

Switching on the PRO device

An external on/off switch is recommended to avoid having to continually open the terminal compartment cover.

4.2 Initial commissioning

Following the initial switch-on, the operating system pre-installed on the device is set up automatically on the device.

NOTICE

Faulty installation

If you change the default values in the BIOS setup or if you turn off the device during installation, you disrupt the installation and the operating system is not installed correctly. The operating safety of the device and the plant is at risk.

Do not switch off the device during the entire installation process. Do not change the default values in the BIOS setup.

Procedure - Switching on the device

1. Set the on/off switch to the "ON" position.

The module carries out a self-test. During the self-test, the following message appears:

```
Press ESC for boot options
```

2. Wait for the message to disappear.
3. Follow the instructions on the screen.
4. Make the region and language settings.

If you want your system language to be international, select English. Information about changing the region and language settings subsequently can be found in the section "Installing the software" under "Maintaining and servicing your device".

Note

Once the operating system has been set up, the device may restart.

5. Type in the product key as required.

The product key is located on the "Certificate of Authentication", in the "Product Key" line.

Result

The interface of the operating system is displayed every time you turn on the device and after the startup routine.

Procedure - Switching off the device

To turn off the device, always select "Start > Shutdown".

If the device is not going to be used for a long period of time after shutdown, set the on/off switch to the "C-" position.

NOTICE

Disconnecting the device from the power supply

The on/off switch does not separate the device from the mains. To de-energize the device, remove the power supply terminal.

4.3 Windows Action Center

Warning from the Windows Action Center

The Action Center checks the status of the device with regard to the important safety aspects listed below. If a problem is found, the Action Center provides recommendations on how you can better protect the device.

- **Firewall:** The Windows Firewall adds protection to the device by blocking network or Internet access to the device by unauthorized users. The firewall is enabled in the delivery state.
- **Antivirus software:** Antivirus programs add protection to the device by searching for and eliminating viruses and other security threats. No antivirus software is installed in the delivery state.
- **Automatic updates:** Using the Automatic Update feature allows Windows to regularly search for the latest critical updates for the device and to install them automatically.
This option is enabled for Windows 7 and Windows Embedded Standard 7 with the factory settings.
- **User Account Control:** User Account Control issues a warning when programs attempt to modify important Windows settings. You can then either acknowledge this warning or prevent the program from changing the Windows settings.

This option is enabled for Windows 7 and Windows Embedded Standard 7 with the factory settings.

4.4 Notes on various device configurations

4.4.1 SIMATIC IPC Wizard 2.1

SIMATIC IPC Wizard for SIMATIC Industrial PCs installs device-specific software and drivers for operating your PC. These software components enable you to set the screen of your SIMATIC device, for example, the brightness.

The SIMATIC IPC Wizard recognizes the existing hardware components and automatically installs the associated software.

- SIMATIC Industrial PCs **with** preinstalled software contain the SIMATIC IPC Wizard that runs automatically during initial commissioning.
- On SIMATIC Industrial PCs **without** preinstalled software, you can install the SIMATIC IPC Wizard from the CD/DVD "Documentation and Drivers" on which the documentation of the SIMATIC IPC Wizard is located.

4.4.1.1 System requirements

Hardware requirements

For the SIMATIC IPC Wizard you require the following hardware:

- PC with connected SIMATIC display: e.g. SIMATIC Panel PC or PC with connected SIMATIC Industrial Flat Panel
- 650 MB of free hard disk space on the PC, C:\ partition
- The SIMATIC IPC display is fully connected:
 - DVI / DP connection for video signals
 - USB connection for touch signals

Note

Connected devices

The SIMATIC IPC Wizard does not support the combination of devices with resistive single-touch screen and capacitive multi-touch screen.

Note for SIMATIC Industrial Flat Panels:

- If you use a SIMATIC Industrial Flat Panel with the PC, connect the Industrial Flat Panel to the PC before initial commissioning.
 - During initial commissioning, multiple SIMATIC Industrial Flat Panels may be connected to the PC.
-

Supported operating systems

The SIMATIC IPC Wizard on PCs runs with the following operating systems:

- Microsoft Windows 32-bit operating system
 - Windows 7 Ultimate with SP1
 - Windows Embedded Standard 7E¹ or 7P with SP1
- Microsoft Windows 64-bit operating system
 - Windows 7 Ultimate with SP1
 - Windows Server 2008 R2
 - Windows Embedded Standard 7E¹ or 7P with SP1

¹ For devices with capacitive multi-touch screen, WES7E is only supported in single-touch mode (see manual "SIMATIC IPC Wizard 2.1", section "Toggling Switch Touch Mode").

Software requirements

- One of the operating systems named in "Supported operating systems" section is installed.
- The driver of the device manufacturer for the graphics adapter is installed.
- The installed graphics driver supports reading of EDID data from the screen.

Note

The Microsoft VESA driver does not support all functions provided by the SIMATIC IPC Wizard. Setup cancels the installation.

4.4.1.2 Installing IPC Wizard

Requirement

- The system requirements are met.
- Do not apply with factory state: If following previous driver versions exist, uninstall them via "Start > Control Panel > Programs and Features":
 - IPC Wizard V1.0
 - IPC Wizard V2.0
 - IPC Switch Touch Mode V2.0.5

Procedure

1. Turn on the PC.
 - With the factory state of some IPCs, the SIMATIC IPC Wizard is pre-installed. The installation starts the first time the PC is switched on.
 - If your SIMATIC IPC was delivered without pre-installed software, start the installation of the SIMATIC IPC Wizard from the "Documentation and Drivers" CD/DVD. Select the appropriate IPC Wizard for your device.

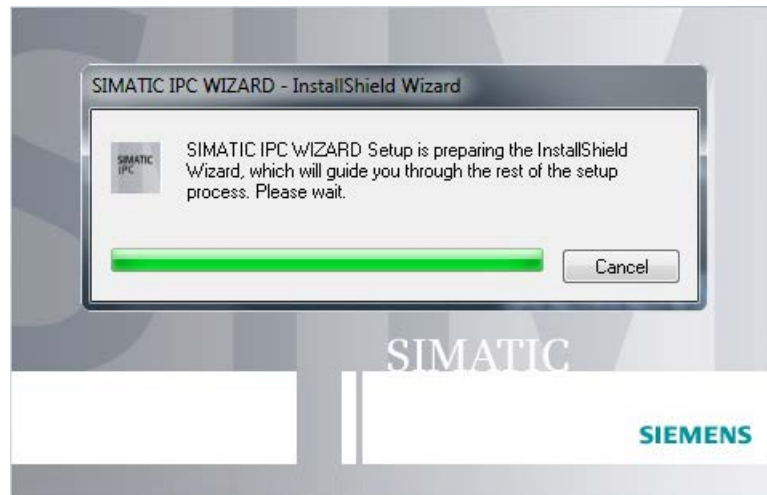

2. Follow the instructions.

The SIMATIC IPC Wizard recognizes the existing hardware components and automatically installs the associated software. This operation can take several minutes.

When all software components are installed, the following dialog is displayed:

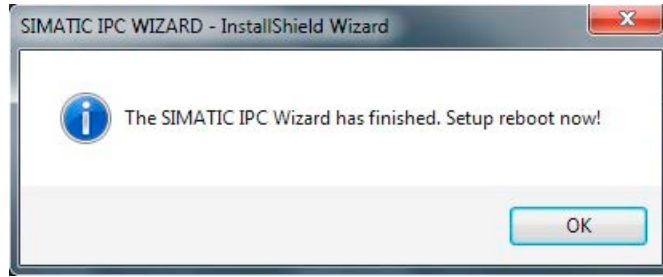

Note

In the case of server operating systems the dialog contains the "Now" and "Later" buttons instead of "OK".

3. Complete the installation with the "OK" button; for server operating systems use "Now".
The PC is restarted.

Result

You have installed the SIMATIC IPC Wizard software.

4.4.2 Notes on the DVD burner

The DVD burner drive is an optional feature. Recording methods supported by the disk drive: Disc-at-once, Track-at-once, Session-at-once, Packet writing. You can write to CD-R, CD-RW, DVD+R, DVD-R, DVD-RW, DVD+RW, DVD-RAM and dual-layer media.

Notes on burning optical data carriers

NOTICE

Danger of data errors when burning data carriers!

Burning is permissible only in an undisturbed environment, i.e. shock and vibration stress must be avoided. Because of heavy fluctuation in the quality of CD-Rs, data may be corrupted in a burning session, even if no error message is initially displayed. The written data can only be verified by comparing these with the source. To be on the safe side, data should be verified after every burning session. When backing up an image, the data should be restored to the hard disk and the system should be rebooted from the hard disk.

Operating the device and device functions

5.1 Operator input options

Depending on your device and the connected I/O devices, the following operator input options are available:

- Integrated keyboard on touch device (not for all IPC)
- Touch screen for touch device

 CAUTION
Unintentional actions with touch screen operation If you touch the touch screen while system-internal processes are running, unintended reactions of the device may be triggered. Do not touch the screen in the following situations: <ul style="list-style-type: none">• During the boot process• When plugging or unplugging USB components• While Scandisk is running• During a BIOS update
NOTICE
Damage to the touch screen Hitting the touch screen with hard objects may damage it and can result in a total failure of the touch screen. Only touch the touch screen with your fingers or a suitable touch stylus.

- Screen keyboard for touch device
- External keyboard, connected via USB
- External mouse, connected via USB

5.2 Operating a device with resistive single touch screen

When you touch an object on the single touch screen, the corresponding function is performed.

WARNING

Personal injury or property damage due to incorrect operation

Incorrect operation of devices with a touch screen can occur. This can result in personal injury or property damage.

Take the following precautions:

- Configure the plant so that safety-related functions are not operated with the touch screen.
- Always touch only a single point on the touch screen.
- Calibrate the touch screen, at the latest when the touch screen becomes inaccurate or does not respond despite repeated touches.
- Switch off the device for cleaning and maintenance.
- Make sure that the touch screen is kept free of dirt.

NOTICE

Damage to the touch screen

Touching the touch screen with pointed or sharp objects can damage it and lead to a significant reduction in service life or even total failure of the touch screen.

Do not touch the touch screen with pointed or hard objects. Only touch the touch screen with your fingers, a touch stylus or an approved touch glove.

Note

Appearance of blisters under extreme ambient conditions

Under extreme environmental conditions such as high atmospheric humidity and temperature, bubbles can form on the touch surface in rare cases. This only affects the appearance and does not represent any functional restriction.

5.3 Operating a capacitive multi-touch screen device and PRO device

You operate the multi-touch screen with one or multiple fingers. You can also operate it using gestures with up to five fingers at a time.

WARNING

Personal injury or property damage due to no earth connection

An inadequate earth connection or the lack of one may cause malfunction of the capacitive touch screen. Functions may not work properly. This can result in personal injury or property damage.

- Always connect the device to an earth conductor.
- The earth conductor from the device must be connected directly to earth with low impedance (short connection, minimum cross-section 2.5 mm²).

You can find additional information on connecting the earth conductor in the section "Connecting the protective earth (Page 56)".

WARNING

Personal injury or property damage due to maloperation

Incorrect operation of devices with a touch screen can occur. This can result in personal injury or property damage.

Take the following precautions:

- Configure the plant so that safety-related functions are not operated with the touch screen.
- Switch off the device for cleaning and maintenance.

WARNING

Danger of malfunction due to improper execution of gestures on the touch screen

If gestures are executed incorrectly on the touch screen with multi-touch function, these gestures may not be recognized or could be recognized incorrectly. The entries made are then not implemented by the device or are implemented incorrectly or in an unintended manner.

Incorrect execution of multi-touch functions can lead to errors in the operation of the plant and thus to physical injury.

Note the following when operating the touch screen with multi-touch function:

- The touch screen reacts to contact on its surface, not to pressure.
- When using a touch pen: Operate the touch screen only with a touch pen for capacitive touch.
- Avoid unintended multiple touches, for example, with your knuckles.

Before you start to operate the device, make sure you are familiar with the multi-touch functions of the Windows operating system, as well as with the application to be used and its functions. Ensure that the gestures which the user executes on the multi-touch display are recognized by the application. It is possible that certain gestures need to be trained beforehand.

Notes on operation

Note when operating the multi-touch screen:

- Surface contact with a diameter of about 5 to 20 mm is required for an operator action to be detected.
- An operation with gloves with a material thickness of <2 mm is detected in most cases. However, check the usefulness of the gloves you are using.
- To avoid incorrect operation, certain inputs are ignored and blocked from further entry:
 - Simultaneous operation with more than 5 fingers.
 - Surface contact with a diameter of > 3 cm, for example, resting the palm of the hand on the touch screen
 - As soon as the touch screen is no longer touched, input is possible again.

Functions of the multi-touch screen

General functions

- Detection of up to 5 finger touches at a time.
- Detection of gestures that are supported by the operating system or the software installed on the device.

Note

Multi-touch operation can provide advanced features or pose limitations depending on the operating system and the software installed on the device. Read the corresponding documentation.

- You do not need to calibrate the touch screen. Some operating systems do offer touch calibration. However, this calibration does not lead to improved accuracy.

Security functions in an industrial environment

The touch screen is locked for security reasons when following happens:

- There is a conductive liquid on the touch screen with ground contact via the enclosure or the operator, for example.
- Electromagnetic interference is present that exceeds the specification according to EN 61000-4-2.

Once the interference is over, the touch screen is no longer locked.

5.4 Operating a touch/key device

Note

Maloperation

If you activate several keys simultaneously, a malfunction on the device cannot be excluded. Only press the function keys one after the other.

Malfunctions of the user software

Always use security features of the KeyTools for security reasons. If you disable them, nevertheless, serious malfunctions of the user software may occur when the additional function keys F1 to F36 are used or if custom key code tables are used.

Risk of damage

Activating a key using a hard or pointed object, for example a screwdriver, reduces the life of the key or can damage it.

External keyboard

Note

The keyboard layout has been set to "English/USA international". If you use a keyboard with a layout other than the "English/USA international" layout, the key codes of the internal and external keyboards might no longer correspond.

This section describes the keyboard assignment of the device in the delivery state.

The assignment of the keys, including the function keys and control of the LEDs, is specified by means of the SIMATIC IPC KeyTools which is installed with the SIMATIC IPC Wizard.

You will find the SIMATIC IPC Wizard operating manual:

- On the "Documentation and Drivers" CD/DVD included in the delivery
- In the IPC Wizard installation folder on the PC after successful installation of the IPC Wizard

Alphanumeric keys













Key	Assignment lower case LED "a/A" inactive	Assignment upper case LED "a/A" active	Assignment SHIFT level LED "a/A" active or inactive
1	<space>\@#%?!"':;<>(){}€\$&%^°~ _1	<space>\@#%?!"':;<>(){}€\$&%^°~ _1	<space>\@#%?!"':;<>(){}€\$&%^°~ !
2	abc2	ABC2	ABC@
3	def3	DEF3	DEF#
4	ghi4	GHI4	GHI\$
5	jkl5	JKL5	JKL%
6	mno6	MNO6	MNO^
7	pqr7	PRQRS7	PQRS&
8	tuv8	TUV8	TUV*
9	wxyz9	WXYZ9	WXYZ(
0	+_*/=0	+_*=?+)	+_*=?+)
.,	.,	.,	><

The characters available for input depend on the text box involved. The figure below shows the entry of an alphanumeric value using the system keys:









Control keys

The following table describes the control keys and their associated functions. With keyboard shortcuts, hold the first key down. Then press the second button.

Key or keyboard shortcut	Function
	Switch between upper and lower case: <ul style="list-style-type: none"> • LED on: Upper case • LED off: Lower case
	Deletes the character left of cursor.
	Tabulator
	Deletes the character to the right of the cursor or the highlighted text.
 	Toggles "overwrite" mode on or off. If "overwrite" mode is switched on, the characters are overwritten to the right of the cursor.
	Open the TIA help, for example, from WinCC The user software can specifically react to the stored key code. You can control the LED by means of the LEDControl program of the IPC Wizard.
	Cancel
	Press: Switches to an additional white key assignment. Hold down: Switches between upper and lower case.
	Acknowledge The user software can specifically react to the stored key code. You can control the LED by means of the LEDControl program of the IPC Wizard.
	General control function for use in keyboard shortcuts.
	General control function for use in keyboard shortcuts.
	Confirm input

Cursor keys

Key or keyboard shortcut	Function
	Moves the cursor, selection or a controller in the specified direction.
	Moves the cursor or selection one page up.
	Moves the cursor or selection one page down.
 	Moves the cursor to the start of the first screen.
 	Moves the cursor to the end of the last screen.

5.5 IPC Wizard functions

Software components

- General for all devices: Panel PC Tools
 - SetBrightness
 - IPCScreenSaver
- Special for devices with resistive single-touch screen: UPDD (Universal Pointing Device Driver) with the following features
 - Advanced touch features
 - Calibrating
- Calibration is not necessary for devices with capacitive multi-touch screen. Depending on your operating system, you may be able calibrate the touch screen through the operating system, although it will not improve the accuracy.

All other functions are described in the manual "SIMATIC IPC Wizard 2.1 and Panel Configuration Center":

- On the "Documentation and Drivers" CD/DVD included in the delivery
- In the IPC Wizard installation directory on the PC

5.6 Extended device functions

5.6.1 Monitoring functions

5.6.1.1 Overview of the monitoring functions

The basic version of the device also provides monitoring functions. The following display, monitoring and control functions are available when the appropriate software is used:

- Temperature monitoring: Overtemperature, undertemperature, or cable break at a temperature sensor
- Monitoring of drives with S.M.A.R.T. functionality
- Watchdog: Hardware or software reset of the computer
- Operating hours counter: Information about total time of operation
- Battery monitoring: The charge level of the battery is monitored.

SIMATIC IPC DiagBase software

Use the functions of the SIMATIC IPC DiagBase software included in the scope of delivery for local monitoring. Use the "DiagBase Management Explorer" application to obtain a clear overview of the controls. Use the DiagBase Alarm Manager to receive notifications about individual alarms.

Note

For more information on SIMATIC IPC DiagBase software functionality, please refer to the relevant Online Help.

SIMATIC IPC DiagMonitor software

SIMATIC IPC DiagMonitor is available on CD (not included in the scope of delivery). The CD contains both the monitoring software and the software for the stations to be monitored. The interface specifications and a library for creating your own applications are also provided.

5.6.1.2 Temperature monitoring/display

Three temperature sensors monitor the temperature of the device at several positions:

- Processor temperature
- Temperature close to the RAM ICs/chips
- Temperature in proximity of the air inlet

A temperature error is triggered under these circumstances:

- The configured low threshold for the temperature has been violated.
- The configured high threshold for the temperature has been violated.

A temperature error causes the following reaction:

Reaction	Option
The DiagBase or DiagMonitor software alerts the user.	None

The temperature error is retained in memory until temperatures have fallen below the thresholds and it is reset by one of the following measures:

- Acknowledgment of the error message by the monitoring software
- Restart of the device

5.6.1.3 Watchdog (WD)

Configuration

You configure the watchdog with the DiagBase or DiagMonitor software.

Function

The watchdog is able to monitor system runtime and informs the user about the different reactions that are triggered if the system does not respond to the watchdog within the specified monitoring time.

A watchdog alarm is retained after a restart and is reset and logged by the DiagBase or DiagMonitor software. The watchdog configuration is retained in the process.

Watchdog reactions

The following reactions can occur if the watchdog is not addressed within the set time:

Option	Reaction
Reset on	Executes a hardware reset when the watchdog expires
Reset off	Executes no action when the watchdog expires
Restart	Restarts the operating system when the watchdog expires
Shutdown	Shuts down the operating system when the watchdog expires

NOTICE
<p>"Reset on" option</p> <p>The "Reset on" option immediately triggers a hardware reset that may result in loss of data under Windows and damage to the installation.</p>

Watchdog monitoring times

The monitoring time can be configured with the DiagBase or DiagMonitor software.

Note

When you change the monitoring time, the change becomes effective immediately.

5.6.1.4 Battery monitoring

The installed backup battery has a limited service life, see section "Replacing back-up battery (devices with 15", 19" or 22" display) (Page 114)". A two-tier battery monitoring checks the status of the backup battery. The SIMATIC DiagBase and SIMATIC DiagMonitor diagnostic software determines the status of the backup battery.

When the first warning level is reached, the battery for buffering CMOS data still has a remaining service life of at least one month.

5.6.2 Enhanced Write Filter

Purpose and function

The EWF (Enhanced Write Filter) is a function that is only available for Windows Embedded operating systems. It provides write protection that can be configured by the user.

You can use the Enhanced Write Filter to boot Windows Embedded Standard from read-only media, for example, CFast card, or provide individual partitions with write protection.

EWF can be used to minimize write access to CFast cards. This is important because the write cycles on CFast cards are limited due to technical reasons. We therefore recommend using EWF if you work with CFast cards.

EWF is indispensable when HORM or compressed NTFS is used.

NOTICE
Activate only one write filter per partition - otherwise you risk data loss
EWF and FBWF are preinstalled in the SIMATIC IPC images.
Ensure that only one write filter is enabled on a partition, otherwise you risk data loss.

Note

The Enhanced Write Filter is deactivated in the Windows Embedded Standard default state.

After the operating system and programs have been installed, you should back up your data and then enable the EWF.

Set EWF

The following programs can be used to install, enable or disable the EWF:

- EWFMgr.EXE
- SIMATIC IPC EWF Manager

The SIMATIC IPC EWF Manager is preinstalled and included on the supplied "Documentation and Drivers" CD/DVD.

Start the SIMATIC IPC EWF Manager as follows:

- "Start > All Programs > Siemens Automation > SIMATIC > EWF Manager > EWF Manager

Configure the SIMATIC IPC EWF Manager as follows:

- "Start > All Programs > Siemens Automation > SIMATIC > EWF Manager > EWF Settings

or

- Click the "SIMATIC IPC EWF Manager" icon in the system tray.

The following functions are available:

Function	Command
Write-protect drive C: Switching on	<code>ewfmgr c: -enable</code>
Write-protect drive C: disable (modified files are transferred)	<code>ewfmgr c: -commitanddisable</code>
Modified files on drive C: Accept	<code>ewfmgr c: -commit</code>
Display information about the EWF drive	<code>ewfmgr c:</code>
Display help	<code>ewfmgr /h</code>

Note

The EWF commands affecting the write protection do not become active until after the next booting process.

Note

The EWF command `ewfmgr c: -commitanddisable` cannot be used in combination with the `-live` option (invalid entry, for example: `ewfmgr c: -commitanddisable -live`).

Special features for the use of Enhanced Write Filters (EWF)

- In the event of a power failure, if the EWF is enabled changes made after the boot sequence on drive C: are lost.
To prevent data loss in the event of a power failure, the use of a UPS is recommended.
- You can save the data in the EWF RAM overlay to the CFast card or the hard disk before you shut down the device. To do so, enter the following command in the command prompt:

```
ewfmgr c: -commit
```

Note

When the system is set to automatically adjust the clock for daylight saving time adjustment, systems without central time management and with activated EWF set the clock forward or backward by one hour in the daylight saving time or standard time period each time the system boots.

The reason for this behavior is that Windows Embedded Standard 7 makes a registry entry that the changeover to daylight saving time has occurred. Since this file is also protected against modification by the EWF, the marker is lost during the boot sequence and the adjustment is made again.

We therefore recommend that you deactivate the automatic adjustment and change the clock manually.

Procedure:

1. Deactivate automatic adjustment in the Control Panel. In the Time Zone tab opened with the menu command Start > Control Panel > Date and Time, remove the check mark from the "Automatically adjust clock for daylight saving changes" check box.
 2. Save the change you made with `ewfmgr c: -commit` and then reboot the system.
-

5.6.3 File Based Write Filter (FBWF)

Purpose and function

With the Feature Pack 2007 for Windows XP Embedded and Windows Embedded Standard 7, Microsoft introduced a second write filter, File Based Write Filter (FBWF).

In contrast to EWF, which protects partitions based on sectors, FBWF works on the file level. When FBWF is enabled, all files and folders of a partition are protected unless they are included in an exception list.

FBWF is disabled by factory default in the operating system images for SIMATIC IPC and must be enabled and configured by the user.

When you enable FBWF, the folders C:\FBWF and D:\FBWF are authorized for writing by default.

Comparison between EWF and FBWF

- You should prefer FBWF, because it is more flexible in its configuration and allows immediate writing without rebooting.
- If you use HORM or compressed NTFS, EWF is indispensable.

 CAUTION
Data loss with several write filters
Both EWF and FBWF are preinstalled in the SIMATIC IPC images. If several writer filters are active on one partition at the same time, you may experience data loss. This may damage the machine or plant.
Make sure that you only activate one write filter for each partition.

Configuring FBWF

FBWF can be configured in command console using the program FBWFMGR.EXE.

Note

- Observe the following syntax: Enter a **space** after the drive designation colon.
- Changes for direct write access only take effect after rebooting.
- Only existing files and folders can be entered in the exception list.

Function	Command
Display the current FBWF status	<code>fbwfmgr /displayconfig</code>
Enable FBWF after the next startup	<code>fbwfmgr /enable</code>
Write to protected files	<code>fbwfmgr /commit c: \Test.txt</code>
Adding/removing elements in the exception list:	
• Add file	<code>fbwfmgr /addexclusion C: \Test.txt</code>
• Add folder	<code>fbwfmgr /addexclusion C: \Test folder</code>
• Remove file	<code>fbwfmgr /removeexclusion C: \Test.txt</code>
• Remove folder	<code>fbwfmgr /removeexclusion C: \Test folder</code>
Call up the help function	<code>fbwfmgr /?</code>

Detailed instructions on FBWF are available on the Internet ([http://msdn.microsoft.com/en-us/library/aa940926\(WinEmbedded.5\).aspx](http://msdn.microsoft.com/en-us/library/aa940926(WinEmbedded.5).aspx)).

5.6.4 Buffer memory MRAM

The motherboard is equipped with an MRAM that applications can use to back up data in the event of a power failure. Failure of the supply voltage for a duration longer than 5 ms is indicated by the DC FAIL signal.

Depending on the system utilization, up to 512 KB can be saved in the MRAM.

A memory window with a maximum size of 512 KB can be displayed by means of PCI address register. The base address is initialized by the BIOS.

A corresponding function is implemented in BIOS to enable the use of MRAM in WinAC RTX.

5.6.5 Active Management Technology (AMT)

AMT (Active Management Technology) is technology for the remote maintenance of computers (simply called AMT-PC in the remainder of the document) and it includes the following functions:

- Keyboard Video Mouse(KVM) Redirection: Using KVM that is integrated in the AMT hardware you access the AMT PC remotely. With KVM, you can also control AMT PCs that have no operating system or a defective operating system. A KVM remote session is always possible with the KVM server integrated in the firmware. This means you can restart the PC and change the BIOS setup remotely.
- Remote power management: AMT PCs can be turned on and off and restarted from another PC.
- SOL (Serial over LAN): Redirection of the data of a serial interface to the network. The main use of the function is text-based remote control of an AMT PC using a console.
- IDE redirection: An ISO file on the help desk PC can be mounted on the AMT PC and used as a DVD drive.

An ISO file contains a memory image of the content of a CD or DVD structured in the ISO 9660 format.

- Remote reboot: An AMT PC can be booted from a bootable ISO file made available by another PC.

SIMATIC IPC Remote Manager

The "SIMATIC IPC Remote Manager" software is available for utilization of the AMT functions with SIMATIC IPCs. The software can be ordered from the Siemens online ordering system. For detailed information about "SIMATIC IPC Remote Manager", refer to the corresponding product documentation: SIMATIC IPC Remote Manager (<http://support.automation.siemens.com/WW/view/en/48707158>)

Typical areas of application and functions of the SIMATIC IPC Remote Manager:

- Remote maintenance of SIMATIC IPC with AMT, for example for service purposes in the case of a defective operating system or for adapting BIOS settings.
- Diagnostics without on-site use
- Convenient service: Access to AMT clients, such as headless systems, without additional hardware
- Resource management

Requirement

- A device with Xeon processor
- A functioning and configured management engine
- A functioning and configured Ethernet connection
- A help desk PC with a functioning and configured Ethernet connection for the full AMT functionality

Configuration of the AMT PC

You configure AMT by means of the BIOS setup and MEBx (Management Engine BIOS Extension). MEBx is a BIOS extension for configuration of AMT (see BIOS description in chapter "Technical specifications").

5.6.6 Trusted Platform Modul (TPM)

Depending on the ordered configuration, the motherboard contains a Trusted Platform Module (TPM). A TPM is a chip that adds important security functions to your device, such as enhanced protection of the PC against unauthorized manipulation by third parties. The current operating systems, for example, Windows 7 and Windows 8, support these security functions.

NOTICE
Import restrictions
TPM technology is subject to legal restrictions in some regions and may not be used there. You could commit a crime by importing or exporting the device in certain countries.
Note the respective import provisions for the TPM module.

Activating the Trusted Platform Module

The TPM can be activated under "Security" in the BIOS setup. Please follow the instructions in the BIOS setup.

Using the Trusted Platform Module

The TPM can be used in Windows 7 with the "BitLocker" drive encrypter. Please follow the instructions for this in the operating system.

Note

Risk of data loss

If you lose the password for the drive encryption, you will not be able to restore the data. You will then lose access to the encrypted drive.

The warranty does not cover a reset of the hardware in the event of a loss of a password.

Please store the password carefully and make sure it is protected against unauthorized access.

Expanding the device and assigning device parameters

6

6.1 Opening the device

6.1.1 Opening the built-in unit

The device must be opened in order to add memory or install the internal CFast card. Read the information in the section "ESD guideline (Page 133)" when doing this.

Opening device with expansions

To open devices with the PCIe card and/or DVD drive expansions, you first have to dismantle these expansions. You can find additional information on this in the following sections:

- Removing a PCIe card (built-in units with PCIe card without DVD drive) (Page 101)
- Installing and removing a DVD drive (built-in unit only) (Page 103)
- Removing a PCIe card (built-in units with PCIe card and DVD drive) (Page 103)

Opening device without expansions

For devices without expansions, only the rear panel of the device is removed.

Requirement

- The device is disconnected from the power supply.
- All cables are removed from the device.
- The device is removed.
- T10 screwdriver

6.1 Opening the device

Procedure

1. Remove the marked screws.

Device with 12" display

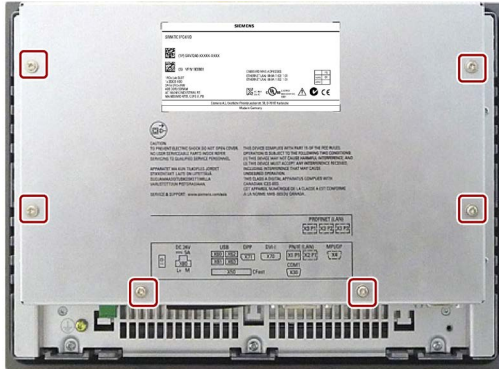

Device with 15", 19" or 22" display

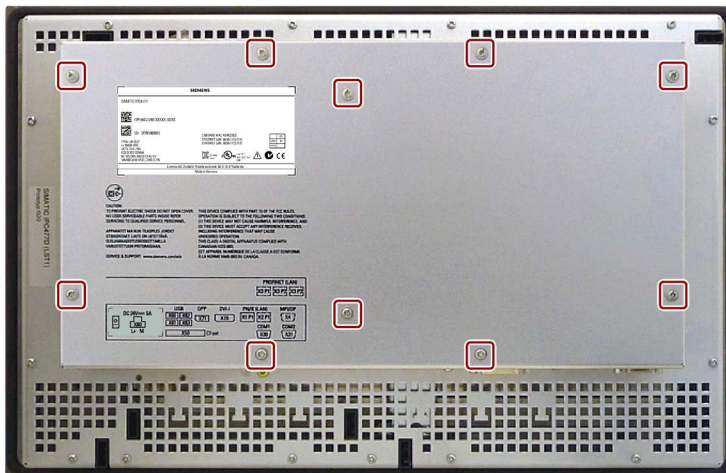

Position and number of the fastening screws are the same for the devices with 15", 19" and 22" display.

2. Remove the rear panel of the device.

6.1.2 Opening and closing the backplane cover PRO device

Requirement

- The device is disconnected from the power supply.
- Torx TX20 screwdriver

Opening the backplane cover

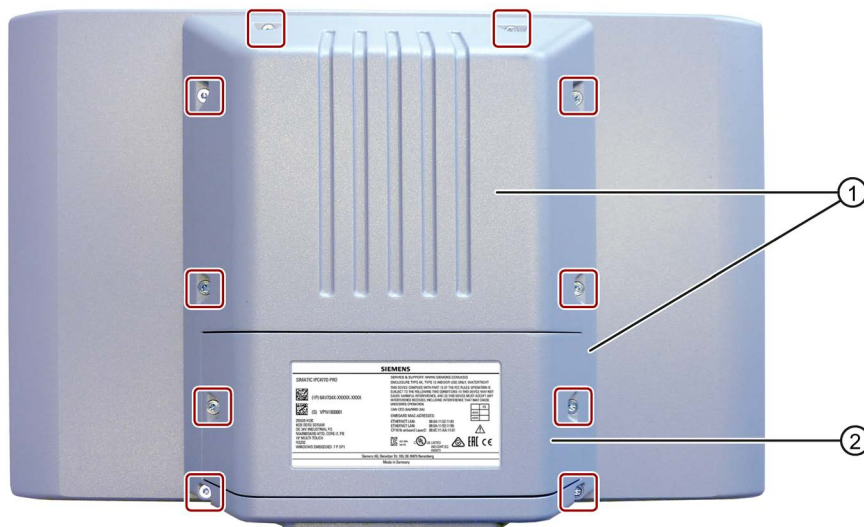

1. Remove all indicated M4x16 screws

NOTICE

Damaging the seal when opening

If the device has not been opened for a long time, the backplane cover and terminal compartment cover may stick to the enclosure caused by the seal. Opening the device with excessive force or with tools will destroy the seal. Spray and water jets as well as penetrating substances can then damage the device.

Open the backplane cover and connection compartment cover gently, without too much pressure.

2. Open the connection compartment cover ② and set it safely aside. (see also section "Connecting a device", "Power supply PRO device (Page 62)").

6.1 Opening the device

3. Open the backplane cover ①, gently open it 90° upwards and place it on the edge of the enclosure, as shown below.

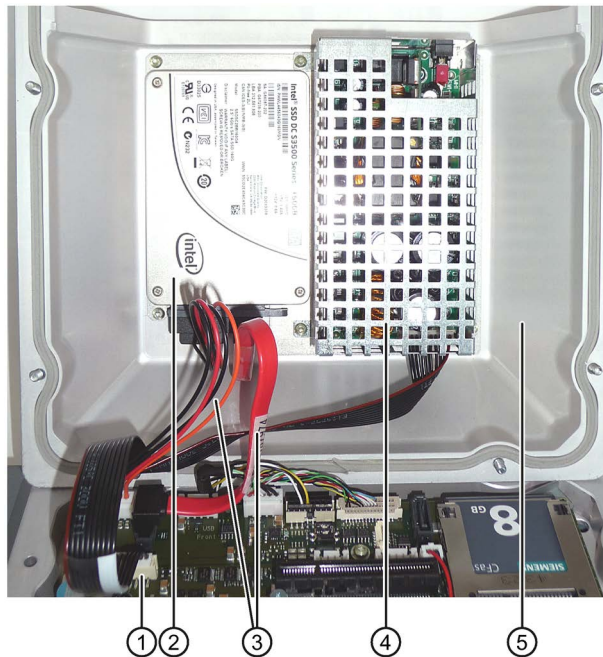

NOTICE
Damage to the device
An SSD ② and power supply ④ are built into the backplane cover and connected to the motherboard with short cables ③. If you open up the backplane cover completely or set it aside, you pull on the cables by their connectors. The device may be damaged.
1. Secure the backplane cover ⑤ from falling down.
2. Pull out the cable connector ③ (see section "Replacing the SSD (PRO device) (Page 120)").
3. Unplug the power supply connector ① on the motherboard.

4. Now you can install and remove the hardware.

Closing the backplane cover

1. Check that the seal is properly seated on the backplane cover.

Note

IP65 degree of protection at risk

If the seal on the backplane cover is damaged, the IP65 degree of protection is at risk. The device must be repaired. Proceed as described in the section Repair information (Page 109).

2. Place the backplane cover on the enclosure. Make sure that no cables are crimped. Secure the backplane cover from falling down.

3. Close the connection compartment cover.

Note

Do not exceed the permissible torque

If you tighten up the screws with a torque > 1.5 Nm, you could may the threading in the enclosure.

4. Tighten the M4x16 screws of the backplane cover in crosswise order using a maximum torque of 1.5 Nm.

6.2 Installing and removing a memory module

The procedures for installing and removing the memory module are the same for all device variants. The procedure is described using the example of the built-in unit.

The motherboard is equipped with one slot for an SO-DIMM DDR3 memory module. You can use it to expand the memory capacity of the device to a maximum of 8 GB.

Note

Use only the memory modules recommended by Siemens AG. You can find additional information in the section "Accessories (Page 25)".

Requirements

- The device is disconnected from the power supply.
- The device is open.
- For 12" touch built-in unit only:
The SSD is removed, see the section "Replacing SSD (device with 12" display) (Page 115)".

Procedure

Note

Note the protective measures required when working with ESD in the section "ESD guideline (Page 133)".

Removal

1. Press the marked latches towards the outside.
The memory module tilts forward.
2. Pull the memory module out of the slot in the direction of the arrow.

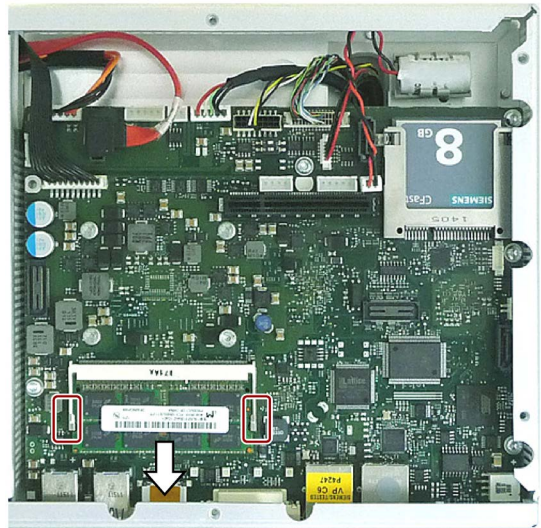

Installation

1. Insert the memory module into the marked slot at an incline with the contact side toward the motherboard.
2. Carefully press the memory module into the contact strip until the latches engage.

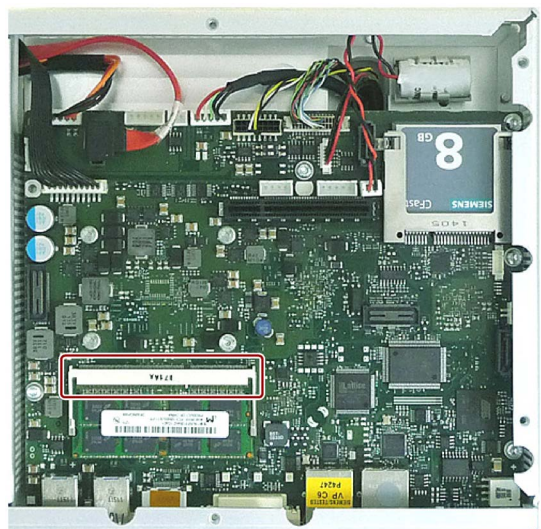

3. Re-install the SSD (for 12" touch built-in unit only) and connect the device.

6.3 Removing a PCIe card (built-in units with PCIe card without DVD drive)

The following section describes the installation and removal of a PCIe card with devices that are expanded only with a PCIe card (not with DVD drive).

Requirements

- The device is disconnected from the power supply.
- The device is removed.
- 1 PCIe card
- 1 T10 screwdriver

Procedure

Note

Note the protective measures required when working with ESD in the section "ESD guideline (Page 133)".

Installation

1. Remove the marked screws and take off the rear panel of the enclosure.
2. Remove the marked screws and pull out the blanking plate.

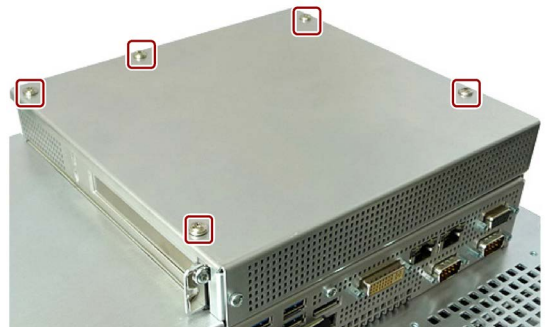

6.3 Removing a PCIe card (built-in units with PCIe card without DVD drive)

3. Loosen the marked screws of the PCIe card holder and push the PCIe card holder to the side.

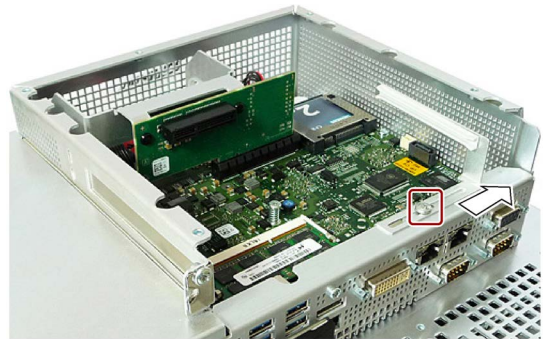

3. Insert the PCIe card in the direction of the arrow and secure this with the marked screw.

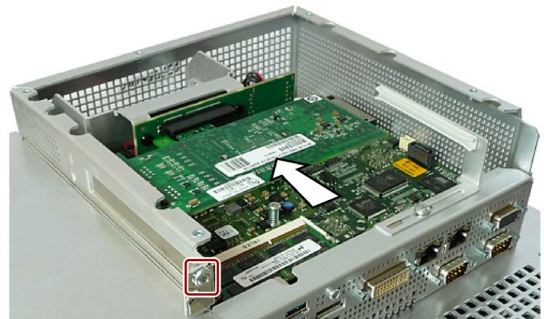

4. Push the PCIe card holder in the direction of the PCIe card and secure this with the marked screw.

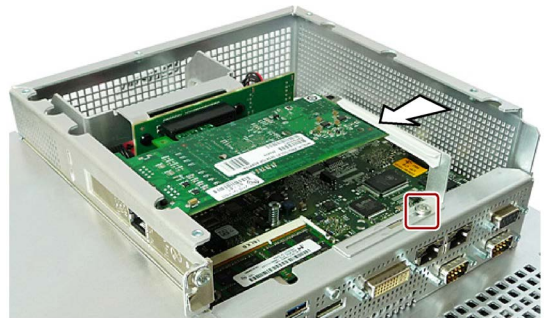

5. Close the device.

Removal

Follow the steps for installation in reverse order.

6.4 Removing a PCIe card (built-in units with PCIe card and DVD drive)

The installation and removal of a PCIe card with devices that are expanded with a PCIe card **and** with a DVD drive, is the same as the description in the section "Removing a PCIe card (built-in units with PCIe card without DVD drive) (Page 101)". Access to the PCIe card slot is covered by the DVD drive, as the following figure shows.

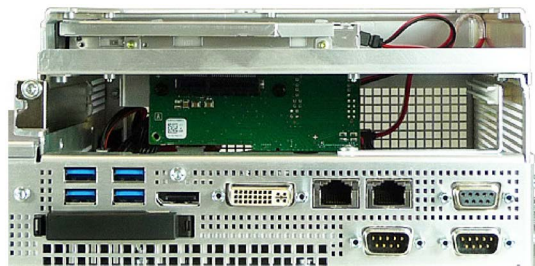

6.5 Installing and removing a DVD drive (built-in unit only)

The following section describes the installation and removal of a DVD drive for devices that are expanded only with a DVD drive (not with a PCIe card).

Requirements

- The device is disconnected from the power supply.
- The device is removed.
- 1 T10 screwdriver

Procedure

Note

Note the protective measures required when working with ESD in the section "ESD guideline (Page 133)".

Installation

1. Remove the marked screws and take off the rear panel of the enclosure.

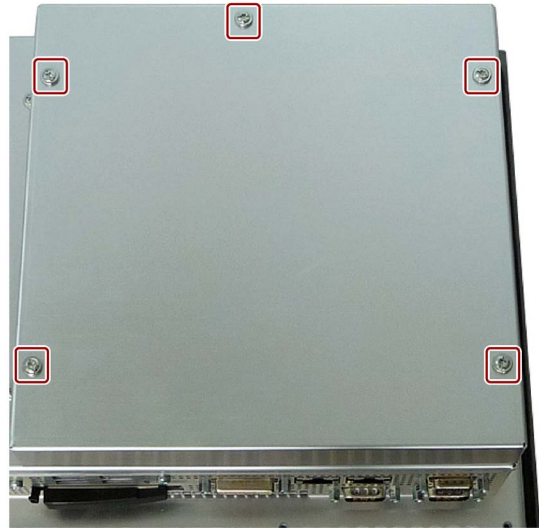

2. Remove the marked screw and pull out the connector in the direction of the arrow.



3. Remove the marked screws.
Also remove the third screw on the opposite side. Lift the DVD drive off the base plate.



Removal

Follow the steps for installation in reverse order.

6.6 Installing and removing a CFast card

6.6.1 Installing and removing a CFast card (external slot)

A slot for a CFast card is located on the bottom of the device. Installing and removing the CFast card is the same for all device variants.

Use only SIMATIC IPC CFast cards for industrial application.

Note

Note the following points:

- Use the slot described here exclusively for a **CFast card**.
- Do not insert **CompactFlash cards (CF cards)** into the slot for the CFast card.
- Always replace the SIMATIC IPC CFast card with a SIMATIC IPC CFast card of the same production version or higher. For the SIMATIC IPC477D, only SIMATIC CFast cards with production version 02 or higher may be used.

The production version can be found on the SIMATIC IPC CFast card, see the section "Accessories (Page 25)".

Requirements

- The device is disconnected from the power supply.
- PRO device only: The connection compartment cover is open (see section "Opening and closing the terminal compartment cover (Page 62)").
- SIMATIC IPC A CFast card that is approved for industrial use.

Procedure

The procedure for installing and removing the CFast card in an external slot is the same for all device variants.

Installation

Note

Carefully insert the CFast card into the slot without applying excess force.

6.6 Installing and removing a CFast card

1. For built-in unit only: Release the lock of the cover.

In so doing, press against the cover in the direction of the arrow. Open the cover completely.



2. For PRO device only: Remove the indicated screws of the cover.



3. Insert the CFast card into the external slot as shown in the figure.

Push the CFast card into the slot until it clicks into place (ballpoint pen mechanics).



4. Close and lock the cover.

Removal

Perform the steps in reverse order.

6.6.2 Installing and removing a CFast card (internal slot)

The procedures for installing and removing the CFast card are the same for all device variants. Use only SIMATIC IPC CFast cards for industrial application.

Note

Note the following points:

- Use the slot described here exclusively for a **CFast card**.
- Do not insert **CompactFlash cards (CF cards)** into the slot for the CFast card.
- Always replace the SIMATIC IPC CFast card with a SIMATIC IPC CFast card of the same production version or higher. For the SIMATIC IPC477D, only SIMATIC CFast cards with production version 02 or higher may be used.

The production version can be found on the SIMATIC CFast card, see the section "Accessories (Page 25)".

Requirements

- The device is disconnected from the power supply.
- The device is open.
- For 12" touch built-in unit only:
The SSD is removed, see the section "Replacing SSD (device with 12" display) (Page 115)".
- SIMATIC IPC A CFast card that is approved for industrial use.

Procedure

Removal

1. For built-in unit: Remove the indicated screws and lift up the retainer.

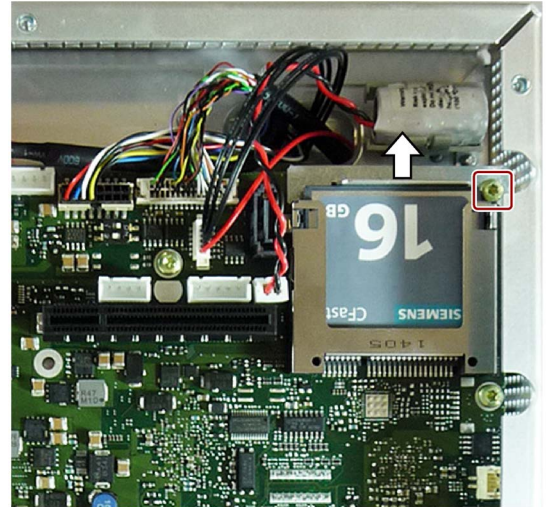

For PRO device: Remove the marked screws and lift off the mounting bracket.

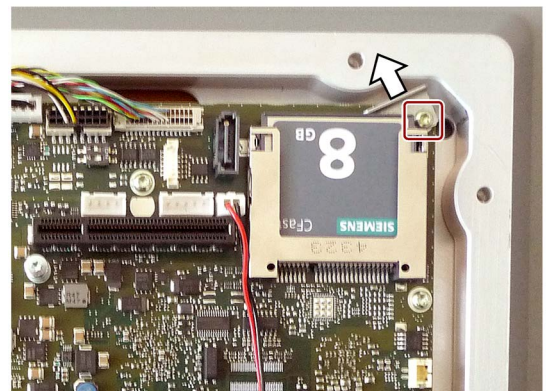

2. Press on the CFAST card in the direction of the arrow.
The CFAST card moves approximately 5 mm out of the slot.
3. Remove the CFAST card.

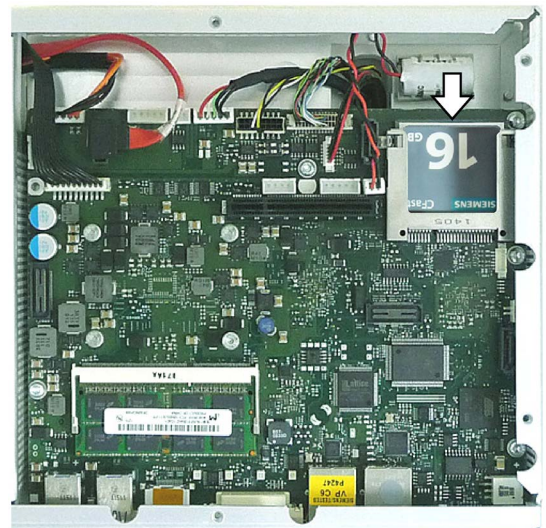

Installation

Note

Carefully insert the CFast card into the slot without applying excess force.

1. Insert the CFast card into the slot.
2. Press on the CFast card in the direction of the arrow.

After you release the CFast card, it will move back approximately 5 mm.

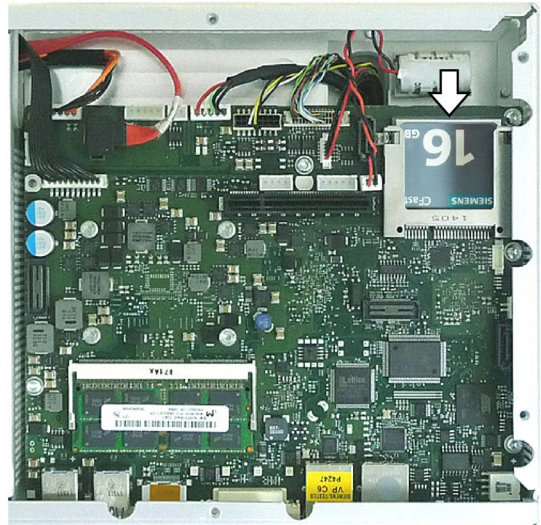

3. Secure the mounting bracket with the marked screw.

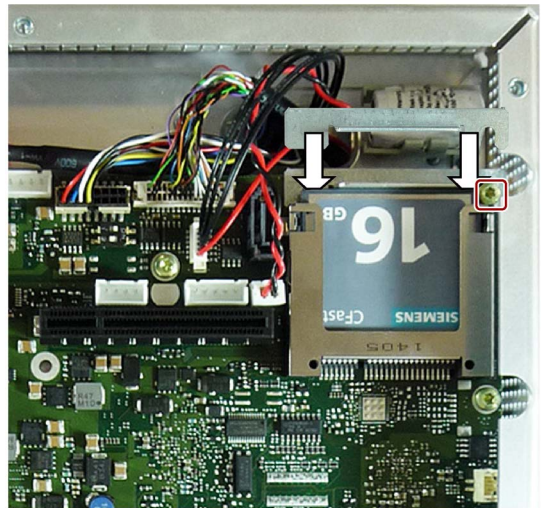

4. For 12" touch built-in unit only:
If your device features an SSD, install this as described in the section "Replacing SSD (device with 12" display) (Page 115)".
5. Close the device.

Maintaining and servicing your device

7.1 Maintenance

To maintain high system availability, we recommend the preventative replacement of those PC components that are subject to wear. The table below indicates the intervals for this replacement.

Component	Replacement interval:
Hard disk drive	3 years
CMOS backup battery	5 years
SSD	Depends on the type of use ¹

¹ The interval for replacement depends greatly on the type of use. A specific interval cannot be given.

All drives are monitored with the software tools DiagBase or DiagMonitor on the basis of their SMART status. As soon the SMART status of the HDD or SSD switches to "Not OK", a message is sent in DiagBase or DiagMonitor, or when you start up the PC. You should then back up your data and replace the drive.

7.2 Repair information

Making repairs

Install only system expansions approved for this device. If you install other expansion devices, you may damage the device or violate the safety requirements and regulations on RF suppression. Contact your technical support team or where you purchased your PC to find out which system expansion devices may safely be installed.

 WARNING
Opening the device Unauthorized opening and improper repairs on the device may result in substantial damage to equipment or endanger the user. If you install or replace a system expansion and damage your device, the warranty will become void. The device may only be repaired by qualified personnel.

Safety when working in and on electrical systems

Work in or on electrical systems may only be carried out by authorized persons. The following safety regulations apply in Germany for the prevention of electric shock and electrocution:

1. Switch off the system
2. Secure the system to prevent it switching back on
3. Check the system to ensure it is de-energized
4. Ground and short the system
5. Cover or shield adjacent live parts

These safety rules are based on the DIN VDE 0105 standard.

Note

These safety steps must always be taken in the above order before any work on electrical systems. Once work on an electrical system is finished, cancel the safety steps starting with the last and finishing with the first.

In accordance with the applicable safety regulations, clearly indicate on an electrical system that work on it is underway.

Observe the safety regulations applicable in the country of operation.

 CAUTION
--

Electrostatic-sensitive components

The device contains electronic components which are destroyed by electrostatic charges. This can result in malfunctions and damage to the machine or plant.

Make sure you take precautionary measures even when you open the device, for example, when opening device doors, device covers or the housing cover. For more information, refer to the section "ESD Guideline (Page 133)"
--

 WARNING
--

Risk of explosion and release of harmful substances
--

Improper handling of lithium batteries can result in an explosion of the batteries. Explosion of the batteries and the released pollutants can cause severe physical injury.
--

Observe all safety and handling instructions for lithium batteries. Do not expose lithium batteries to flames and do not solder the battery cell. Do not recharge, open, or short lithium batteries. Do not reverse lithium battery polarity or heat the batteries to over 100°C. Keep lithium batteries out of direct sunlight and protect them from moisture and condensation.
--

Note the following when handling lithium batteries:

- Worn batteries jeopardize the function of the device. Charge the battery in good time.
- Replace lithium batteries only with batteries of the same type or a type recommended by the manufacturer.

The article number for the lithium battery is A5E30314053.

NOTICE

Batteries and rechargeables pollute the environment

Do not dispose of used batteries or rechargeables in household waste. Users are obliged by law to return used batteries and rechargeable batteries. You as the user are legally responsible disposing used batteries or rechargeables in a correct manner.

Observe the following rules for the disposal of batteries and rechargeables:

- Dispose of used batteries and rechargeable batteries separately as hazardous waste in accordance with local regulations.
- You can take used batteries and rechargeable batteries to public collection points and wherever batteries and rechargeable batteries of the type in question are sold.
- Mark used battery containers as "Used batteries".

Limitation of liability

All technical specifications and approvals for the device apply only if you use expansion components that have a valid CE approval (CE marking). The installation instructions for expansion components in the associated documentation must be observed.

UL approval of the device only applies when the UL-approved components are used according to their "Conditions of Acceptability".

We are not liable for functional limitations caused by the use of third-party devices or components.

See also

Spare parts and repairs (<http://support.automation.siemens.com/WW/view/en/16611927>)

7.3 Cleaning the Device Front

The device is designed for low-maintenance operation. You should still clean the device front regularly, however.

CAUTION

Unwanted reactions when cleaning the device

You risk unintentional actuation of control elements if you clean the device while it is switched on.

You may possibly trigger unwanted actions of the device or controller that are liable to cause personal injury or damage to the machinery.

Always switch off the device before you clean it.

Cleaning Agents

NOTICE

Damage to the HMI device caused by impermissible cleaning agents

Impermissible and unsuitable cleaning agents may cause damage to the HMI device.

Use dish soap or foaming screen cleaner only as cleaning agents. Do not use the following cleaning agents:

- Aggressive solvents or scouring powder
- Steam jets
- Compressed air

Cleaning the Device Front

1. Switch off the device.
2. Dampen the cleaning cloth.
3. Spray the cleaning agent on the cloth and not directly on the device.
4. Clean the device with the cleaning cloth.

7.4 Installing and removing hardware

7.4.1 Built-in unit

7.4.1.1 Replacing back-up battery (device with 12" display)

Requirement

- The device is disconnected from the power supply.
- The device is open, see the section "Opening the built-in unit (Page 95)".
- Replacement battery

Procedure

Removal

NOTICE

Time setting is lost

The time setting and the setup settings are deleted if it takes longer than 30 seconds to replace the battery. The device is no longer synchronized. Time-controlled programs will no longer run or will run at the wrong time. This may damage the plant.

Reset the device time.

1. Remove the marked battery connector.
2. Grip the marked battery and pull it up and out of its holder.

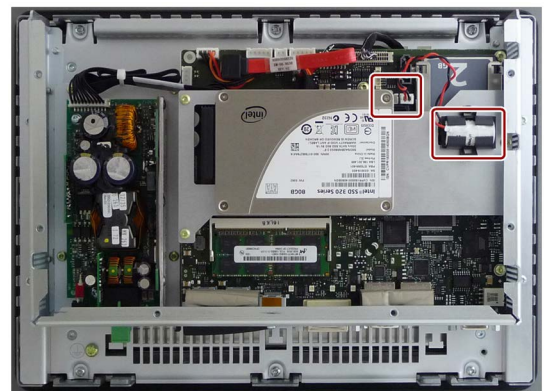

Installation

For installation, follow the removal steps in reverse order and close the device.

See also

General safety instructions (Page 29)

7.4.1.2 Replacing back-up battery (devices with 15", 19" or 22" display)

Requirements

- The device is disconnected from the power supply.
- The device is open, see the section "Opening the built-in unit (Page 95)".
- Replacement battery

Procedure

Removal

NOTICE

Time setting is lost

The time and the setup settings are deleted if it takes longer than 30 seconds to replace the battery. The device is no longer synchronized. Time-controlled programs will no longer run or will run at the wrong time. This may damage the plant.

Reset the device time.

1. Remove the marked battery connector.
2. Grip the marked battery and pull it up and out of its holder.

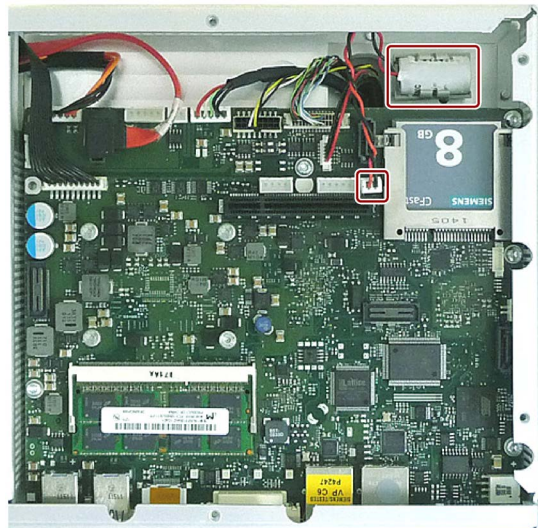

Installation

For installation, follow the removal steps in reverse order and close the device.

See also

General safety instructions (Page 29)

Repair information (Page 109)

7.4.1.3 Replacing SSD (device with 12" display)

Requirement

- The device is disconnected from the power supply.
- The device is open, see the section "Opening the built-in unit (Page 95)".
- SSD
- T10 screwdriver

Procedure

Removal

1. Unplug the two marked connectors. Press the metal connector latch at the front of the connector to remove the SATA connector.
2. Remove the back-up battery from its holder as indicated by the arrow. Do not remove the battery connector. If you remove the battery connector, you need to configure the BIOS setup again and you have to set the date and time once again.
3. Remove the marked screws and take the hard disk holder with the SSD out of the device.
4. Flip the hard disk holder and remove the marked screws.
5. Remove the connectors from the SSD port.

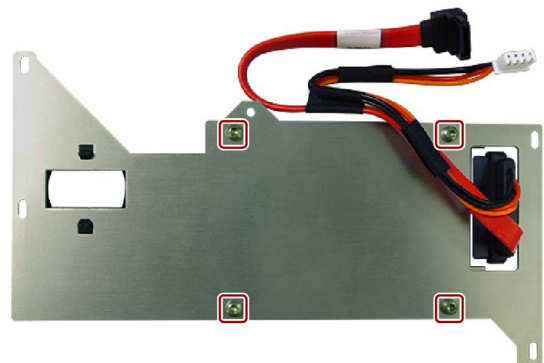
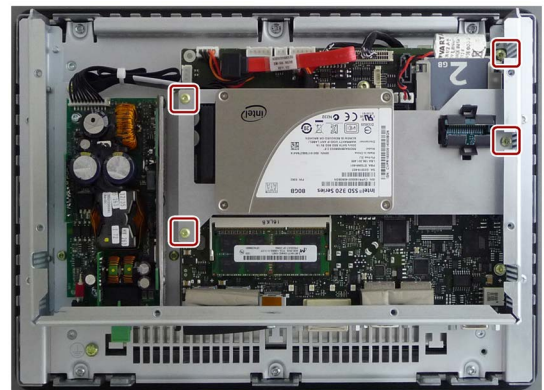
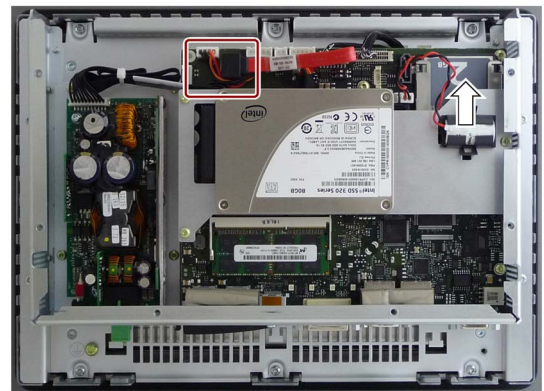

Installation

For installation, follow the steps for removal in reverse order. Insert the backup battery back into the holder and close the device.

See also

Repair information (Page 109)

Replacing back-up battery (device with 12" display) (Page 113)

7.4.1.4 Replacing the SSD (devices with 15", 19" or 22" display)

Depending on the version ordered, an SSD may be installed in the touch device with 15", 19", or 22" display and in the touch/key device.

Requirement

- The device is disconnected from the power supply.
- The device is open, see the section "Opening the built-in unit (Page 95)".
- SSD
- T10 screwdriver

Procedure

Removal

1. Remove the marked screws.

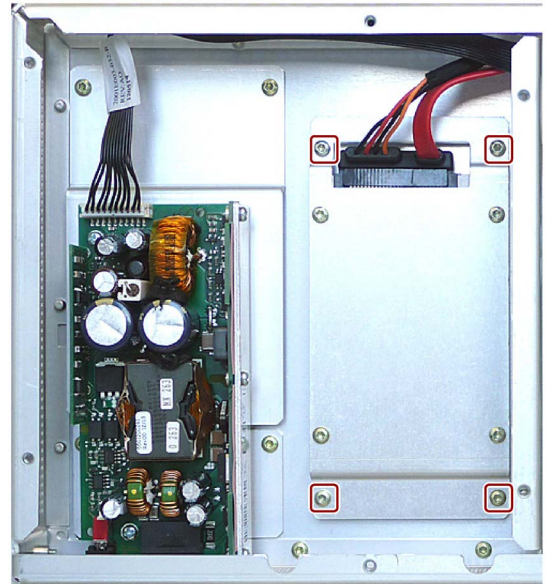

2. Remove the marked screws.
3. Remove the connectors from the port.

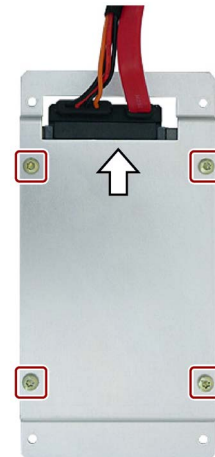

Installation

Note

Screws in various lengths

This procedure involves screws of various lengths:

- Screws to fasten the SSD to the hard disk holder (short screws)
- Screws to fasten the hard disk holder to the device (long screws)

Make sure you use the correct screws for each operation.

For installation, follow the removal steps in reverse order and close the device.

See also

Repair information (Page 109)

7.4.1.5 Replacing HDD

This chapter applies to devices with hard disk drive.

Requirement

- The device is disconnected from the power supply.
- The device is open, see the section "Opening the built-in unit (Page 95)".
- Hard disk drive
- T10 screwdriver

Procedure

Removal

1. Remove the marked screws.
2. Carefully remove the base plate with the hard disk fastened to it.
3. Remove the connector in the direction of the arrow.

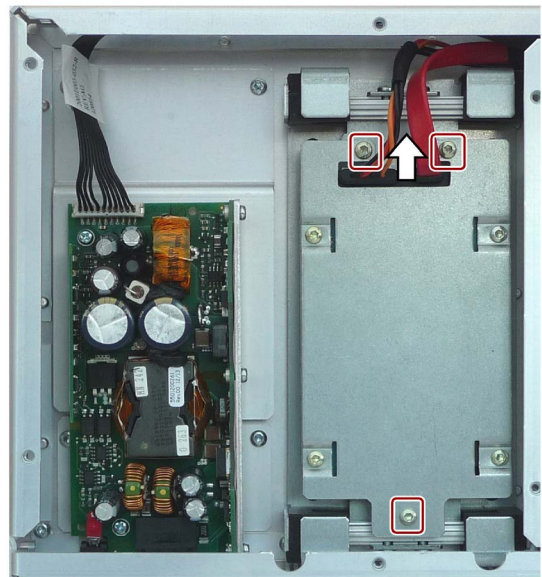

4. Detach the hard disk from the base plate. Remove the four screws that connect the hard disk and the base plate.

Installation

Note

Screws in various lengths

This procedure involves screws of various lengths:

- Screws to fasten the SSD to the hard disk holder (short screws)
- Screws to fasten the hard disk holder to the device (long screws)

Make sure you use the correct screws for each operation.

For installation, follow these steps in reverse and close the device.

7.4.2 PRO device

7.4.2.1 Replacing the backup battery (PRO device)

Requirements

- The device is disconnected from the power supply.
- The device is open, see the section "Opening and closing the backplane cover PRO device (Page 97)".
- The power supply connector is pulled out.
- Replacement battery

Procedure

NOTICE

Time setting is lost

The time and the setup settings are deleted if it takes longer than 30 seconds to replace the battery. The device is no longer synchronized. Time-controlled programs will no longer run or will run at the wrong time. This may damage the plant.

Reset the device time.

1. Unplug the indicated connector on the extension cable. The battery connector with extension cable remains in the device.
2. Grip the marked battery and pull it up and out of its holder.

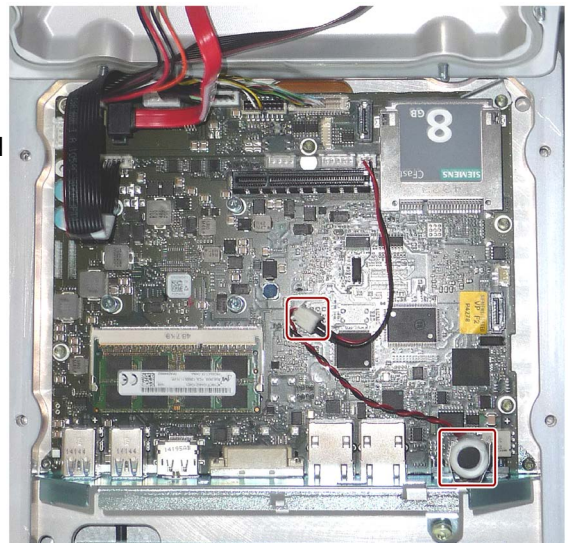

For installation, proceed in the reverse order and reconnect the device.

7.4.2.2 Replacing the SSD (PRO device)

Requirements

- The device is disconnected from the power supply.
- The device is open, see the section "Opening and closing the backplane cover PRO device (Page 97)".
- An SSD. The SSD is installed in the backplane cover.
- T10 screwdriver

Procedure

1. Pull out the connectors ①, ② and ③. Take into account the safety latch of the cable in doing so.
2. Set the backplane cover down flat.
3. Remove the indicated pan-head screws and firmly hold down the cover ④ of the power supply.
4. Remove the drive cage with the SSD and power supply and place it with the back facing up.

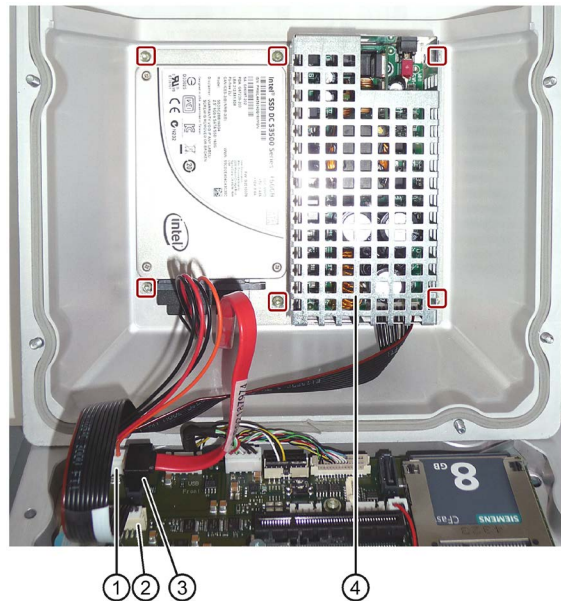

5. Remove the indicated countersunk screws on the back.
6. Remove the SSD.
7. Pull out the SSD connector from the interface.

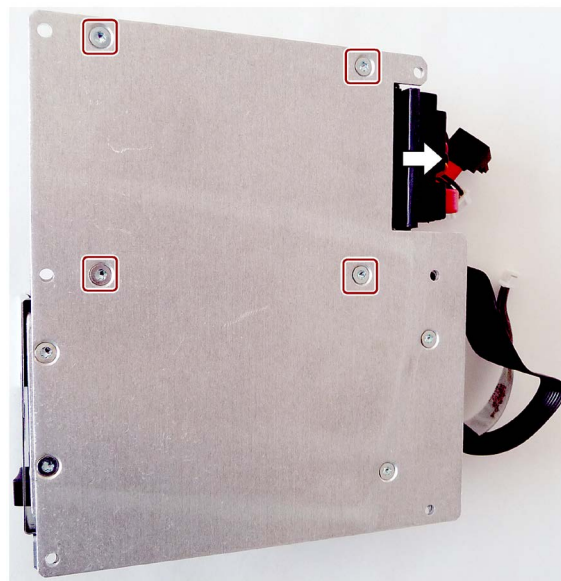

Installation

Note

Do not exceed the maximum permissible torques

If you tighten the screws with too much torque, the threading in enclosure and drive cage may be damaged. Note the maximum permitted torques:

0.8 Nm for the following connections:

- M3 x 5 pan-head screws for mounting the drive cage in the backplane cover

0.5 Nm for the following connections:

- M3 x 5 countersunk screws for mounting the SSD drive in the drive cage
-

Proceed in reverse order for the installation.

1. In step 1 above, ensure that the connectors are not installed with reverse polarity.
2. Close the device.

7.5 Installing the software

7.5.1 Reinstalling the operating system

7.5.1.1 General installation procedure

If your operating system is no longer functioning correctly, you can reinstall it in one of two ways:

- With the Recovery DVD and "Documentation and Drivers" CD/DVD (only with Windows 7 Ultimate)
- With the Restore DVD

Recovery DVD (only with Windows 7 Ultimate)

NOTICE
Windows Embedded
The Recovery DVD is not available for Windows Embedded operating systems.

The Recovery DVD contains the installation program with tools for configuring the drives and installing the operating system and the supported languages (MUI package).

The basic language of the installed operating system is English. To add other languages, install these languages from the Recovery DVD at a later time.

"Documentation and Drivers" CD/DVD

The "Documentation and Drivers" CD/DVD contains the documentation and the hardware drivers.

Restore DVD

The Restore DVD is included in the product package when you have ordered a device with operating system. The DVD contains an image file with the original software package: Operating system with installed hardware drivers and monitoring software, e.g. DiagBase.

7.5.1.2 Restoring the factory state of the software using the Restore DVD

You can restore the original factory software using the Restore DVD. The DVD contains the necessary images and tools for transferring the factory software to the hard disk / SSD or memory card of your PC. The following options are available for restoring software:

- Restore the entire hard disk / SSD or memory card with drive C: (system) and drive D: Use the "Restore entire hard disk" option.
- Restore drive C: only This allows you to retain any user data on drive D: Use the "Restore system partition only" option.

NOTICE

Data are deleted

When you select the "Restore entire hard disk" option, all data, user settings and authorizations or license keys on the hard disk are lost. The hard disk is reset to the delivery state with partitions "C:" and "D:".

If the "Restore system partition only" option is set, all files on drive C: (System) are deleted. All data, user settings and existing authorizations or license keys on drive "C:" will be lost. Drive "C:" on the hard drive is completely erased, reformatted and the original software is written to it.

Restoring the factory state

1. If the device is not equipped with a DVD drive, connect a USB DVD ROM drive to the device.
2. Insert the Restore DVD into the drive.
3. Restart the device.
4. Press <ESC> when the following BIOS message appears:

Press Esc for Boot Options

The BIOS selection menu is displayed when initialization is completed.

5. To boot from the Restore DVD, select the Boot Manager.
6. Select the CD/DVD drive from the Boot Manager and confirm the entry.
7. **Immediately** press any key when you see the following prompt to install the operating system from the Restore DVD.

Press any key to boot from CD or DVD ..

After a few seconds, you will see the installation program.

8. Follow the on-screen instructions.

Note

The "USB Boot" option has to be set to "Enabled" in the BIOS menu "Boot" so that the device can address a USB DVD-ROM drive.

7.5.1.3 Windows 7

Installation of Windows 7

Note

Specific information on using the Windows operating systems is available in the following manual (not included in the product package): Microsoft Windows 7 - Technical Reference (MS Press No. 5927).

Requirement

- USB keyboard
- Internal or external DVD ROM drive
- Recovery DVD for the operating system you want to install, which is included in the product package.

Procedure

1. Enable "USB Boot" in the BIOS setup.
2. Insert the Recovery DVD into the DVD drive.
3. Restart the device.
4. Press <ESC> when the following BIOS message appears:

```
Press Esc for Boot Options
```

The BIOS selection menu is displayed when initialization is completed.
5. To boot from the Recovery DVD, select the Boot Manager.
6. Select the CD/DVD drive from the Boot Manager and confirm the entry.
7. **Immediately** press any key when you see the following prompt to install the operating system from the Recovery DVD.

```
Press any key to boot from CD or DVD ..
```

After a few seconds, you will see the "Install Windows" installation program.

NOTICE

Data deleted

All data, user settings and existing authorizations or license keys on drive C: are deleted during the installation of Windows 7.

- Back up all data.
- Check the data and time in the BIOS setup, "Main" menu and correct the displayed time if necessary.

8. Follow the instructions in the installation program "Install Windows". You will find additional information in the operating system manual.

"Install Windows" installation program

The language of the installation program and the operating system you want to install has been preset to English. You can change the language of the operating system after the installation. You can find information on this in section: "Setting up the language selection by means of the Multilanguage User Interface (MUI) (Page 124)".

You can set up partitions during the installation process.

The recommended minimum size for Windows 7 system partition varies, depending on the amount of RAM and additional software that you are going to use. Information about the partitioning of the data volume in the delivery state is available in section Partitioning in Windows 7 Ultimate (Page 127).

Setting up the language selection by means of the Multilanguage User Interface (MUI)

You can set the display of menus, dialogs or other information, such as date and time, to a different language. For this purpose, you can either select one of the preinstalled languages or install a new language package.

The following command sequences are described in English. Depending on the default setting, they can be displayed in another language.

Setting up the language selection in Windows 7

Note

Specific information on setting up the language selection for Windows operating systems can be found in the manual "Microsoft Windows 7, Technical Reference (MS Press No. 5927)", not included in the product package.

Changing the settings for language, region and formats of a registered user account

1. Choose:
"Start > Control Panel > Clock, Language, and Region > Regional and Language Options"
2. You can make the desired changes in the "Formats", "Location" and "Keyboards and Languages" tabs.

Changing the settings for language, region and formats of the system account and the standard user account

You can change the settings for language, region and formats of the system account (for example, the language in the user login dialog) and the settings of the standard user account (standard setting for new users). The settings of the registered user are copied to the system account and the standard user account for this purpose.

1. Choose:

"Start > Control Panel > Clock, Language, and Region > Regional and Language Options"

2. You can make the required changes in the "Administrative" tab. You copy the settings by clicking the respective button.

Installing new language packages

The available language packages are described in the section "Configuration of the device". Some language packages are available on the Recovery DVD in the "Languagepacks" folder.

1. Choose:

"Start > Control Panel > Clock, Language, and Region > Regional and Language Options"

2. Select the "Keyboards and Languages" tab.
3. Click the "Install/uninstall languages" button and make the required changes.

Recovery DVD languages

The following additional languages can be installed from the Operating System Recovery DVD:

Language	Windows 7
German	X
English	X
French	X
Italian	X
Spanish	X
Chinese (Hong Kong)	X
Chinese (simplified)	X
Chinese (Taiwan)	X
Japanese	X
Russian	X

7.5.1.4 Windows Embedded Standard

General installation procedure

If your software becomes corrupt for any reason, you can reinstall it from the Restore DVD. The Restore DVD contains an image file for the device memory with the original software package (operating system with installed hardware drivers).

Note

You require a USB keyboard and a USB DVD-ROM drive to reinstall the operating system. Before performing the new installation, you should check the date and time set in the BIOS Setup, "Main" menu, and correct these if necessary.

Setting up language selection

You can change the language using the supplied Restore DVD. The Restore DVD contains the required language packages and help for changing the system language.

Note

Note the license terms of Windows Embedded Standard 7

Note the license terms for Windows Embedded Standard 7 and especially the extended software terms of the Siemens AG.

You can find the license terms in the delivered document "MICROSOFT SOFTWARE LICENSE TERMS for Windows Embedded Standard 7" and in the system drive under \\Windows\System32\\license.rtf.

Change system language

1. Connect a USB DVD-ROM drive to the device, if necessary.
2. Insert the Restore DVD into the DVD drive.
3. Restart the device and press "F2" to access BIOS.
4. Switch to the "Boot" menu and select the setting "USB Boot" = "Enabled".
5. Switch to the "Exit" menu and select "Exit Saving Changes".
6. Restart the device and press the "F12" key until you are in the "Boot Manager".
7. Select the DVD drive and press "Enter" to boot from the DVD drive.
8. Follow the instructions on the screen.
9. After selecting the menu dialog language of the Restore DVD, select the menu entry "Manage language packages".

Depending on the current language setup, you have the following options in the "Manage language packages" menu:

- Display language settings
- Install language
- Change language
- Uninstall installed language

7.5.2 Partitioning data media

7.5.2.1 Partitioning in Windows Embedded Standard 7

You will need to reconfigure the partitions after installing a new drive, to repair corrupt partitions or to change the partitioning.

Partitioning of the SIMATIC IPC CFast card

The SIMATIC IPC CFast card for Windows Embedded Standard 7 comes configured with the following default partitions:

Partition	Name	Size of the card		File system
		8 GB	16 GB	
1st Partition	SYSTEM	7 GB	12 GB	NTFS (compressed)
2nd Partition	DATA	Remainder	Remainder	NTFS (compressed)

* Due to partitioning/formatting, the actual CFast capacity does not correspond to the memory size specified on the SIMATIC IPC CFast card.

Partitioning of the HDD or SSD

In the delivery state, the following partitions are configured on the HDD or SSD drive with the Windows Embedded Standard 7 operating system:

Partition	Name	Size of data medium		File system
		>64 GB	>100 GB	
Primary	System	50 GB	100 GB	NTFS not compressed
Second	Data	Remainder	Remainder	NTFS not compressed

To restore the partitions to their original delivery state, we recommend you use the software **SIMATIC IPC Image & Partition Creator**. Additional information is available in the accompanying documentation.

7.5.2.2 Partitioning in Windows 7 Ultimate

You will need to reconfigure the partitions after installing a new drive, to repair corrupt partitions or to change the partitioning.

Partitioning of the HDD or SSD

In delivery state, the following default partitions are set up on the HDD or SSD for the Windows 7 Ultimate operating system:

Partition	Name	Size of data medium			File system
		< 54 GB	>54 GB	>100 GB	
Primary	Boot	100 MB	100 MB	100 MB	Automatically set up by installation program
Second	System	40 GB	50 GB	100 GB	NTFS not compressed
Third	Data	Remainder	Remainder	Remainder	NTFS not compressed

7.5.2.3 Adapting partitions in Windows 7 Ultimate and Windows Embedded Standard 7

With the disk management, you can adapt the partitioning of your drives.

You can reduce or delete an available partition to acquire unassigned memory space, which you can use to set up a new partition or to increase an existing partition.

Note

Data lost in the case of deleting a partition!

If you delete a partition, all the data on this partition is lost.

Back up your data before you change partitions.

Requirement

You are logged on as an administrator.

Reduce partition

A partition can only be reduced when sufficient space is available.

1. Click with the right mouse button on the partition to be reduced and click on "Reduce size".
2. Follow the instructions.

Increase partition

Note

To increase a partition, this partition must not be formatted with a file system or the partition must be formatted with an "NTFS" file system.

1. Click in the partition manager with the right mouse button on the partition to be increased and click on "Increase size".
2. Follow the instructions on the screen.

Additional information is available in the "Help" menu under "Help topics" and "Search".

7.5.3 Installing drivers and software

Requirement

- DVD "Documentation and Drivers" provided with the product package.

Procedure

1. If your device has no DVD drive, connect an external USB DVD drive to a USB port.
2. Insert the supplied "Documentation and Drivers" DVD.
3. Start the "Start" program.
4. Accept the licensing conditions.
5. Select "Drivers" from the index.
6. Select the device and operating system.
7. Select the desired driver
8. Open the folder with the driver information: Click on the link next to "Driver path".
9. Start the setup program in this folder.

Note

For a new installation of Windows operating systems, the chipset driver must be installed before all other drivers, if required.

7.5.4 Update installation

7.5.4.1 Updating the operating system

Windows

The latest updates for the Windows operating system are available on the Internet at Microsoft (<http://www.microsoft.com>) and on the device in the Start menu "Start > All Programs > Windows Update > Check for updates".

Note

Before you install new drivers or operating system updates for Windows MUI versions, configure the regional menu and dialog settings and the default English (US) language.

other operating systems

Contact the corresponding manufacturer.

7.5.4.2 Installing or updating application programs and drivers

To install software from a CD and/or floppy disk in a Windows operating system, you must connect a suitable external USB drive to the computer.

The drivers for USB floppy drives and USB CD-R drives are included in the operating system and do not have to be installed separately.

For information about installation of SIMATIC software packages, refer to the corresponding manufacturer documentation.

For updates of third-party drivers and application programs, contact the respective manufacturer.

7.5.4.3 CP 1616 onboard

NDIS device driver

Read the information in the Installation_CP16xx.pdf document and on the supplied "Documentation and Drivers" CD/DVD.

PROFINET IO

Read the information of the SIMATIC devices and SIMATIC NET documentation listed in the section "PROFINET (Page 68)".

7.5.5 Backing up data

We recommend that you use the **SIMATIC IPC Image & Partition Creator** software tool for data backups in Windows Embedded Standard 7 and Windows 7 (as of V3.4). This tool provides convenient and efficient functions for backing up and restoring the full content of memory cards, hard disks and individual partitions (images).

SIMATIC IPC Image & Partition Creator supports the burning of DVD media only. You can order the tool using the Siemens online ordering system (<https://mall.industry.siemens.com>). For more information about SIMATIC IPC Image & Partition Creator, refer to its product documentation.

7.6 Recycling and disposal

The devices described in these operating instructions can be recycled thanks to their low level of pollutants. Contact a certified disposal service company for environmentally sound recycling and disposal of your old devices.

Technical information

8.1 Certificates and approvals



The device meets the guidelines listed in the following sections.

EC Declaration of Conformity

The associated declaration of conformity is available on the Internet at the following address:
Panel PC certificates
(<http://support.automation.siemens.com/WW/view/en/10805572/134200>).

ISO 9001 certificate

The Siemens quality management system for our entire product creation process (development, production and sales) meets the requirements of ISO 9001:2008.

This has been certified by DQS (the German society for the certification of quality management systems).

Certificate no.: 001323 QM08

Software license agreements

If the device is supplied with preinstalled software, you must observe the corresponding license agreements.

UL approval



- Underwriters Laboratories (UL) in accordance with standard UL508 (IND.CONT.EQ), File E85972
- Canadian National Standard CAN/CSA-C22.2 No. 142

FCC and Canada

USA	
Federal Communications Commission Radio Frequency Interference Statement	This equipment has been tested and found to comply with the limits for a Class A digital device, pursuant to Part 15 of the FCC Rules. These limits are designed to provide reasonable protection against harmful interference when the equipment is operated in a commercial environment. This equipment generates, uses, and can radiate radio frequency energy and, if not installed and used in accordance with the instruction manual, may cause harmful interference to radio communications. Operation of this equipment in a residential area is likely to cause harmful interference in which case the user will be required to correct the interference at his own expense.
Shielded Cables	Shielded cables must be used with this equipment to maintain compliance with FCC regulations.
Modifications	Changes or modifications not expressly approved by the manufacturer could void the user's authority to operate the equipment.
Conditions of Operations	This device complies with Part 15 of the FCC Rules. Operation is subject to the following two conditions: (1) this device may not cause harmful interference, and (2) this device must accept any interference received, including interference that may cause undesired operation.

CANADA	
Canadian Notice	This Class A digital apparatus complies with Canadian ICES-003 (A).
Avis Canadien	Cet appareil numérique de la classe A est conforme à la norme NMB-003 (A) du Canada.

AUSTRALIA / NEW ZEALAND



This product meets the requirements of EN 61000-6-4:2007 Generic standards - Emission standard for industrial environments.

This product meets the requirements of the standard EN 61000-6-4:2007 Generic standards – Emission standard for industrial environments.

KOREA



This product meets the requirements of Korean certification.

This product satisfies the requirement of the Korean Certification (KC Mark).

이 기기는 업무용(A급) 전자파 적합기기로서 판매자 또는 사용자는 이 점을 주의하시기 바라며 가정 외의 지역에서 사용하는 것을 목적으로 합니다.

8.2 Directives and declarations

Electromagnetic compatibility

This product meets the requirements of EC Directive 2004/108/EC "Electromagnetic Compatibility".

The device is designed for the following areas of application corresponding to the CE marking:

Scope of application	Requirements for	
	Interference emission	Immunity to interference
Industrial area	EN 61000-6-4:2007 +A1:2011	EN 61000-6-2:2005

The devices with AC power supply comply with the standards EN 61000-3-2:2006 +A1:2009 +A2:2009 (harmonic currents) and EN 61000-3-3:2008 (voltage fluctuations and flicker).

Low-voltage directive

The device with AC power supply complies with the requirements of the EC Directive 2006/95/EC "Low Voltage Directive". Compliance with this standard has been verified according to EN 60950-1:2006 + A11:2009 +A1:2010 +A12:2011.

8.2.1 ESD guideline

What does ESD mean?

An electronic module is equipped with highly integrated components. Due to their design, electronic components are highly sensitive to overvoltage and thus to the discharge of static electricity. Such electronic components or modules are labeled as electrostatic sensitive devices.

The following abbreviations are commonly used for electrostatic sensitive devices:

- ESD – Electrostatic sensitive device
- ESD – Electrostatic Sensitive Device as a common international designation

Electrostatic sensitive devices can be labeled with an appropriate symbol.



NOTICE

Damage to ESD from touch

Electrostatic sensitive devices, ESD, can be destroyed by voltages which are far below the human perception limit. If you touch a component or electrical connections of a module without discharging any electrostatic energy, these voltages may arise.

The damage to a module by an overvoltage can often not be immediately detected and only becomes evident after an extended period of operation. The consequences are incalculable and range from unforeseeable malfunctions to a total failure of the machine or system.

Avoid touching components directly. Make sure that persons, the workstation and the packaging are properly grounded.

Charge

Every person without a conductive connection to the electrical potential of his/her surroundings can be electrostatically charged.

The material with which this person comes into contact is of particular significance. The figure shows the maximum electrostatic voltages with which a person is charged, depending on humidity and material. These values conform to the specifications of IEC 61000-4-2.

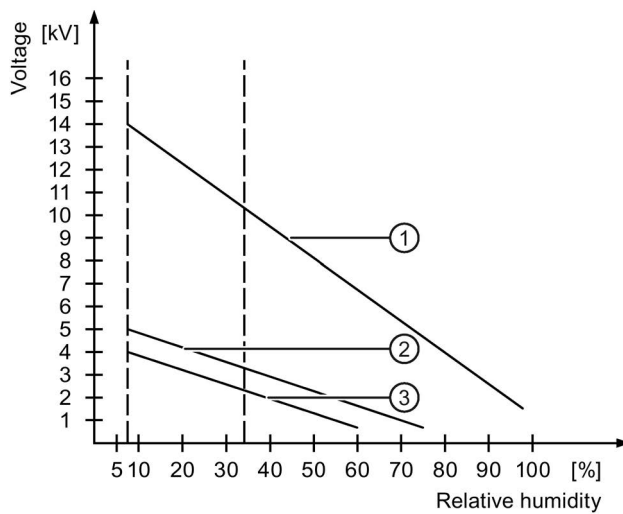

- ① Synthetic materials
- ② Wool
- ③ Antistatic materials such as wood or concrete

NOTICE

Grounding measures

There is no equipotential bonding without grounding. An electrostatic charge is not discharged and may damage the ESD.

Protect yourself against discharge of static electricity. When working with electrostatic sensitive devices, make sure that the person and the workplace are properly grounded.

Protective measures against discharge of static electricity

- Disconnect the power supply before you install or remove modules which are sensitive to ESD.
- Pay attention to good grounding:
 - When handling electrostatic sensitive devices, make sure that persons, the workstation and devices, tools and packaging used are properly grounded. This way you avoid static discharge.
- Avoid direct contact:
 - As a general rule, do not touch electrostatic sensitive devices, except in the case of unavoidable maintenance work.
 - Hold the modules at their edge so that you do not touch the connector pins or conductor paths. This way, the discharge energy does not reach and damage the sensitive components.
 - Discharge your body electrostatically before you take a measurement at a module. Do so by touching grounded metallic parts. Always use grounded measuring instruments.

8.3 Dimension drawings

8.3.1 Dimension drawing of 15" device with capacitive multi-touch screen

The figure shows the front view and directly associated side view and top view of a device without PCI expansion and DVD drive. The side view and top view of a device with PCI expansion and DVD drive are shown beyond at a distance.

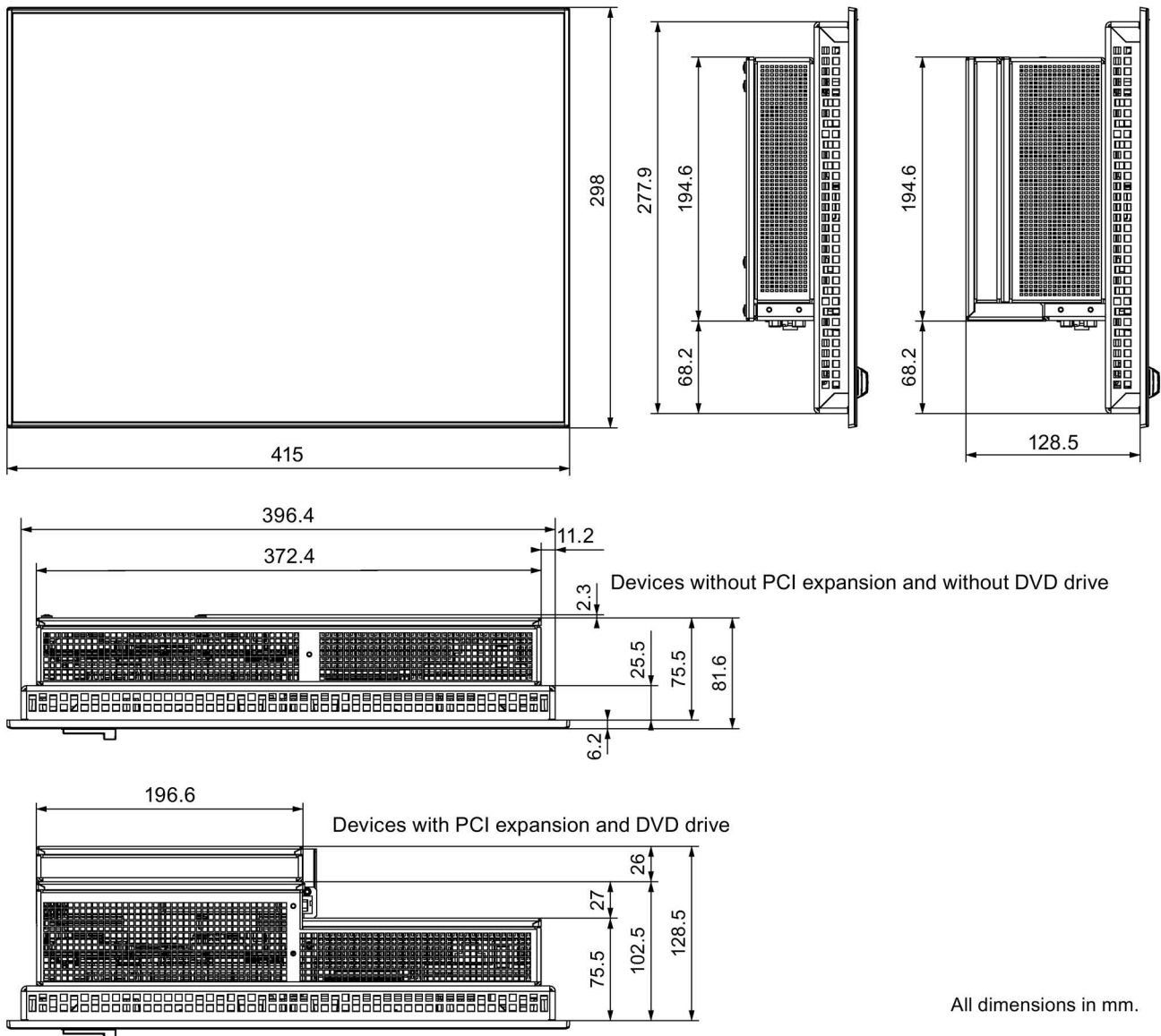

Device depths

- Without expansion cards: 75.5 mm
- With DVD drive: 101.5 mm
- With PCIe card: 102.5 mm
- With DVD drive and PCIe card: 128.5 mm

8.3.2 Dimension drawing of 19" device with capacitive multi-touch screen

The figure shows the front view and directly associated side view and top view of a device without PCI expansion and DVD drive. The side view and top view of a device with PCI expansion and DVD drive are shown beyond at a distance.

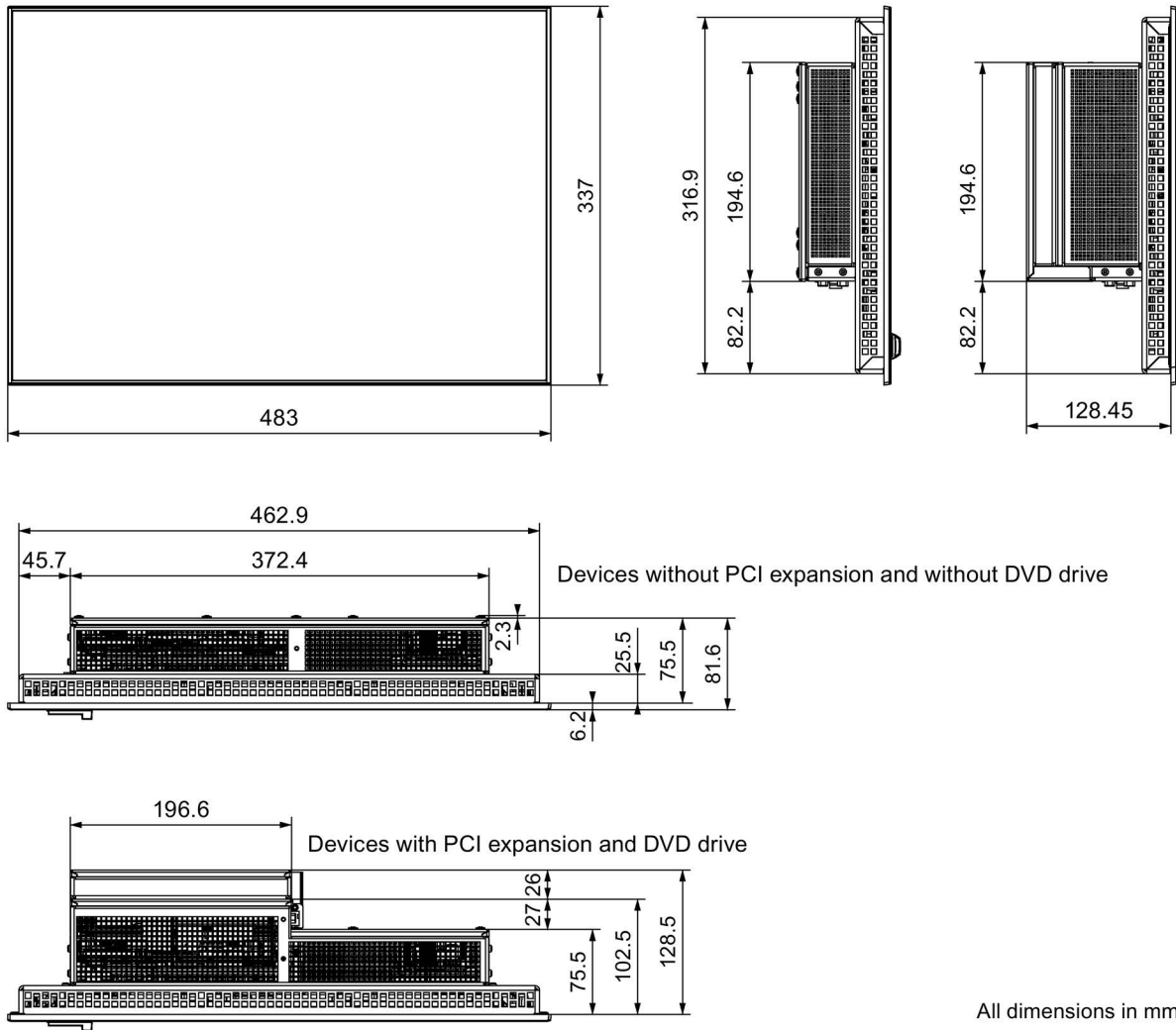

Device depths

- Without expansion cards: 75.5 mm
- With DVD drive: 101.5 mm
- With PCIe card: 102.5 mm
- With DVD drive and PCIe card: 128.5 mm

8.3.3 Dimension drawing of 22" device with capacitive multi-touch screen

The figure shows the front view and directly associated side view and top view of a device without PCI expansion and DVD drive. The side view and top view of a device with PCI expansion and DVD drive are shown beyond at a distance.

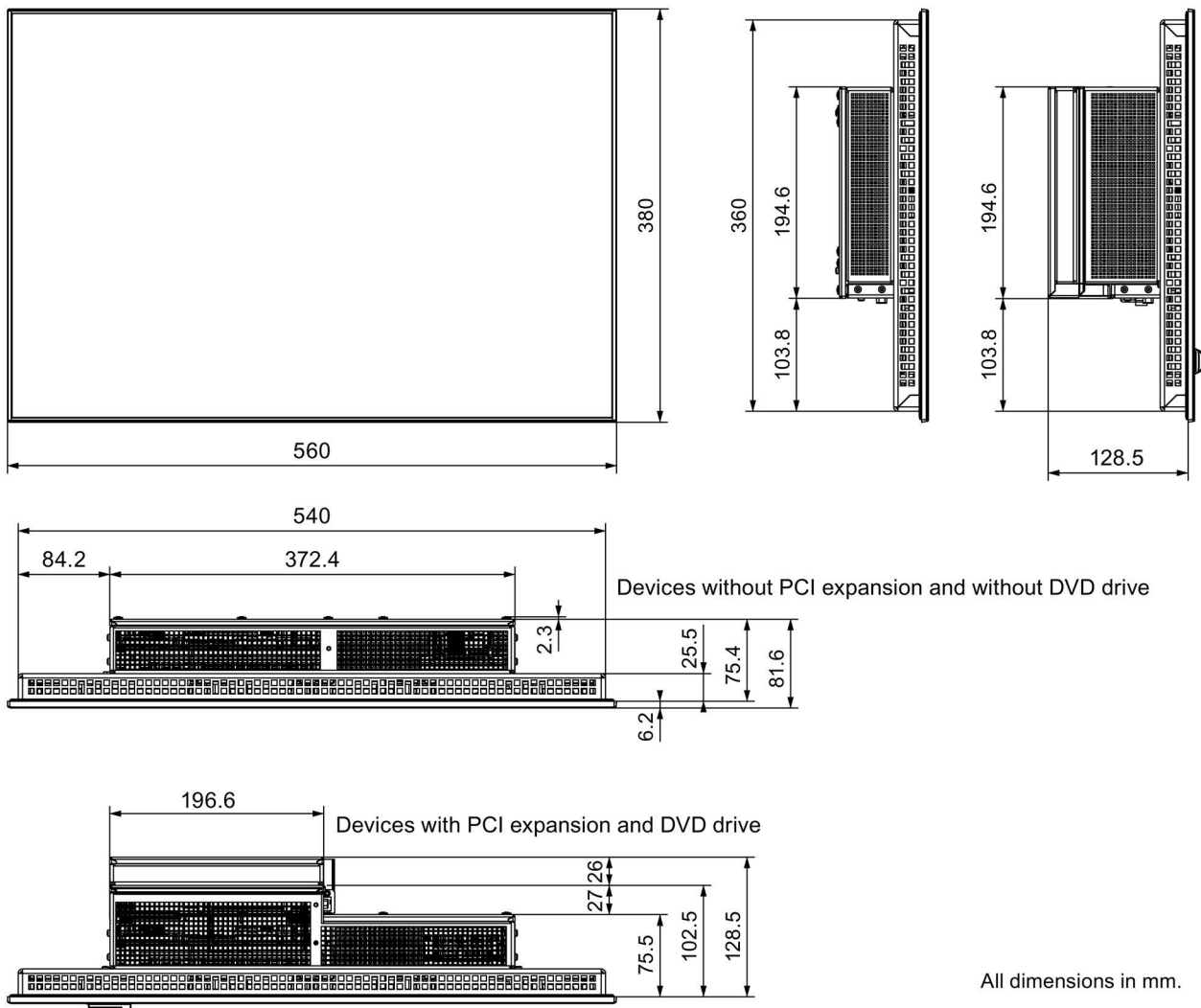

Device depths

- Without expansion cards: 75.5 mm
- With DVD drive: 101.5 mm
- With PCIe card: 102.5 mm
- With DVD drive and PCIe card: 128.5 mm

8.3.4 Dimension drawing 19" PRO device with capacitive multi-touch screen

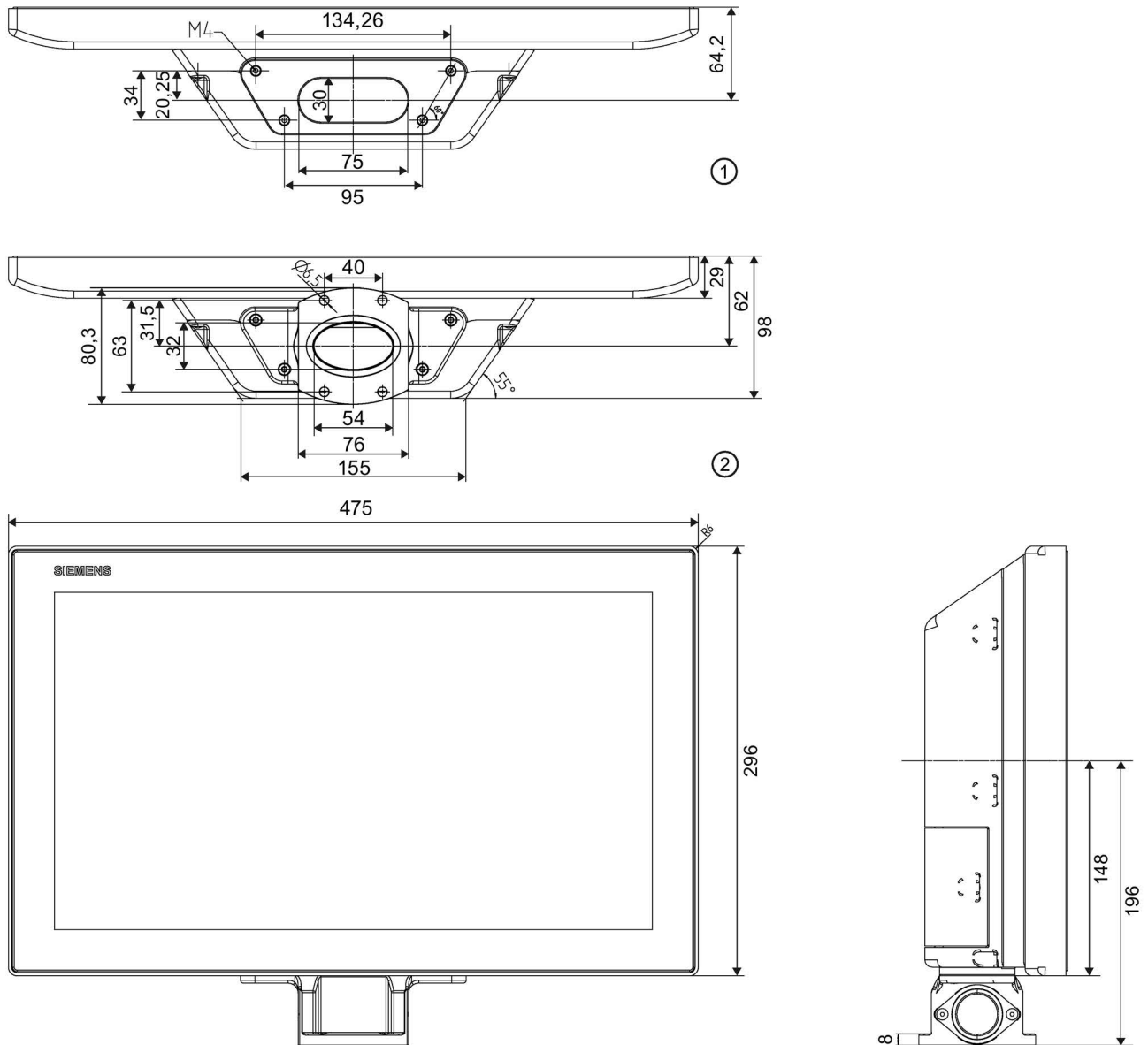

- ① Without base adapter
- ② With base adapter

All dimensions in mm

8.3.5 Dimension drawing of 12" device with resistive single-touch screen

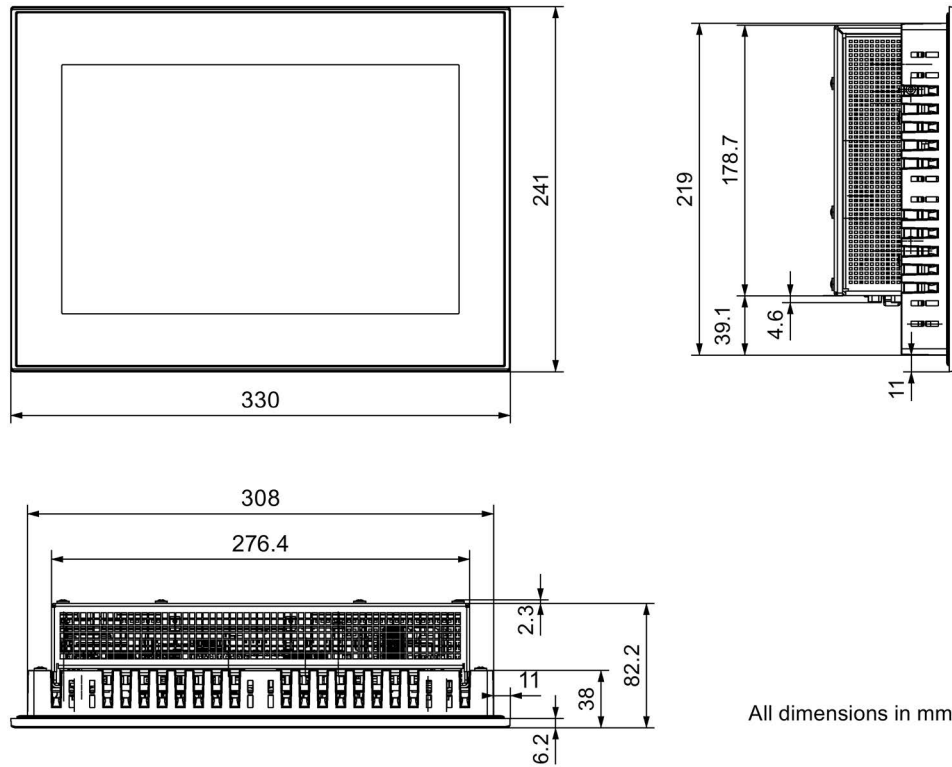

All dimensions in mm.

8.3.6 Dimension drawing of 15" device with resistive single-touch screen

The figure shows the front view and directly associated side view and top view of a device without PCI expansion and DVD drive. The side view and top view of a device with PCI expansion and DVD drive are shown beyond at a distance.

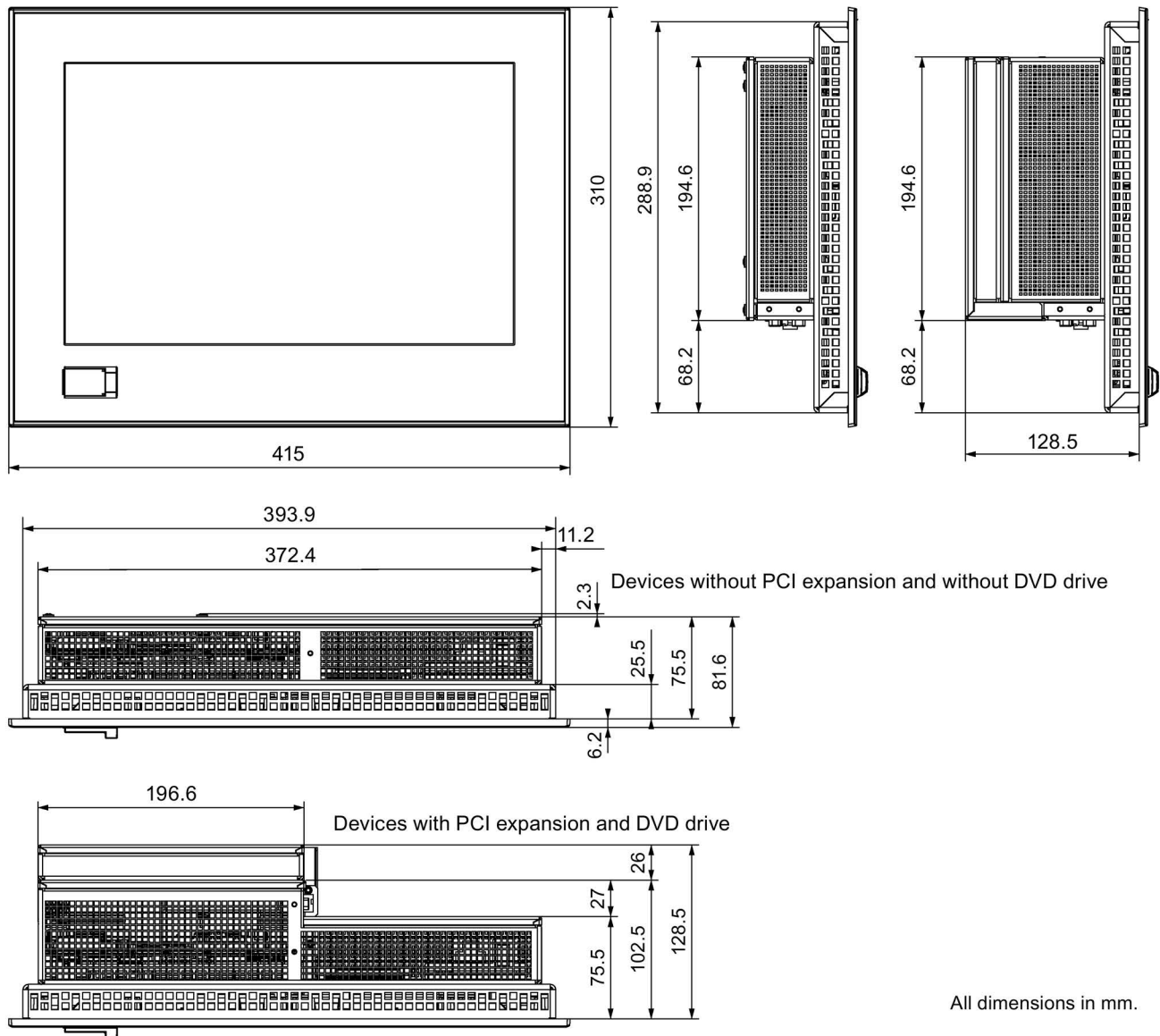

Device depths

- Without expansion cards: 75.5 mm
- With DVD drive: 101.5 mm
- With PCIe card: 102.5 mm
- With DVD drive and PCIe card: 128.5 mm

8.3.7 Dimension drawing of 19" device with resistive single-touch screen

The figure shows the front view and directly associated side view and top view of a device without PCI expansion and DVD drive. The side view and top view of a device with PCI expansion and DVD drive are shown beyond at a distance.

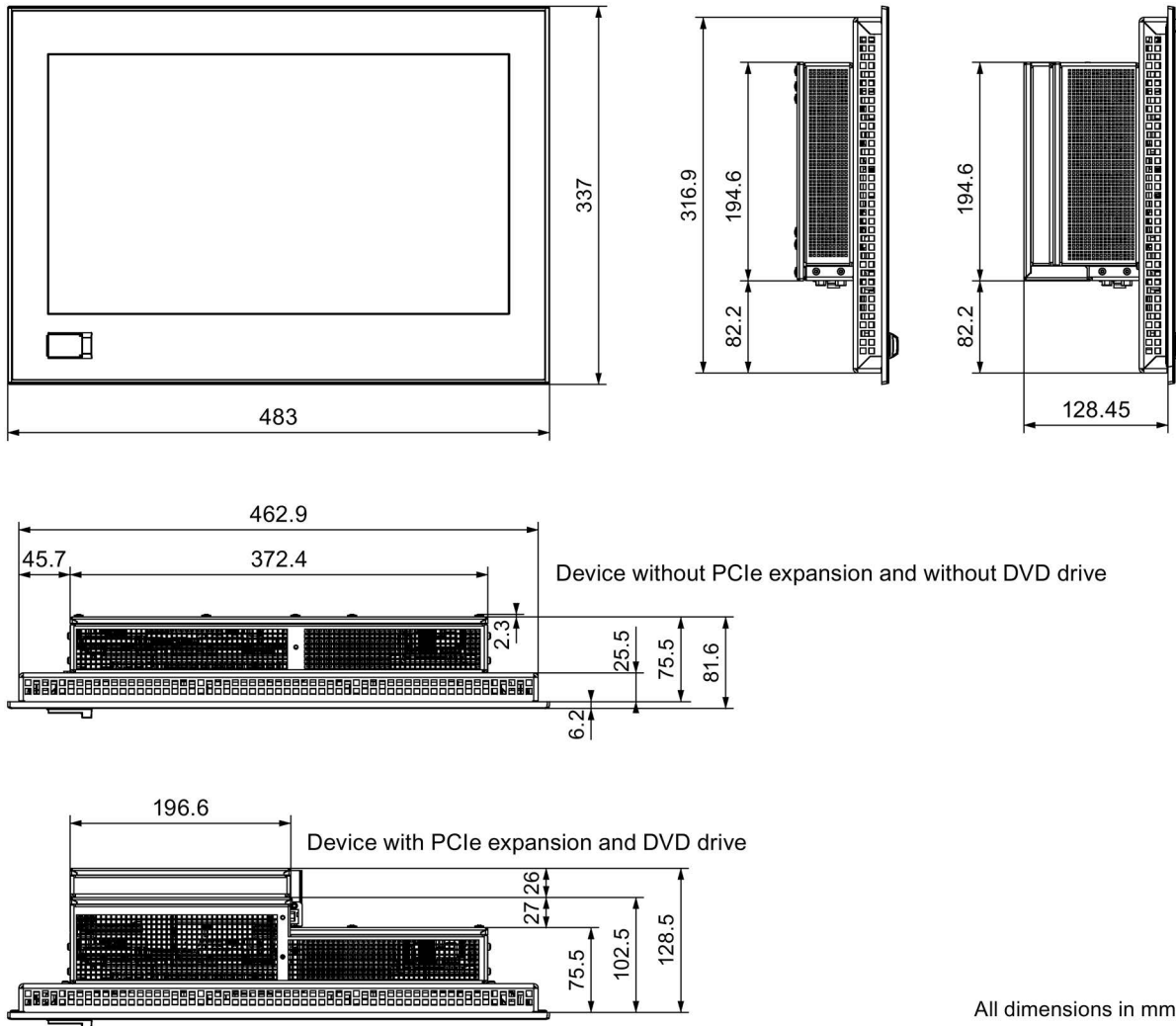

All dimensions in mm.

Device depths

- Without expansion cards: 75.5 mm
- With DVD drive: 101.5 mm
- With PCIe card: 102.5 mm
- With DVD drive and PCIe card: 128.5 mm

8.3.8 Dimension drawing of 22" device with resistive single-touch screen

The figure shows the front view and directly associated side view and top view of a device without PCI expansion and DVD drive. The side view and top view of a device with PCI expansion and DVD drive are shown beyond at a distance.

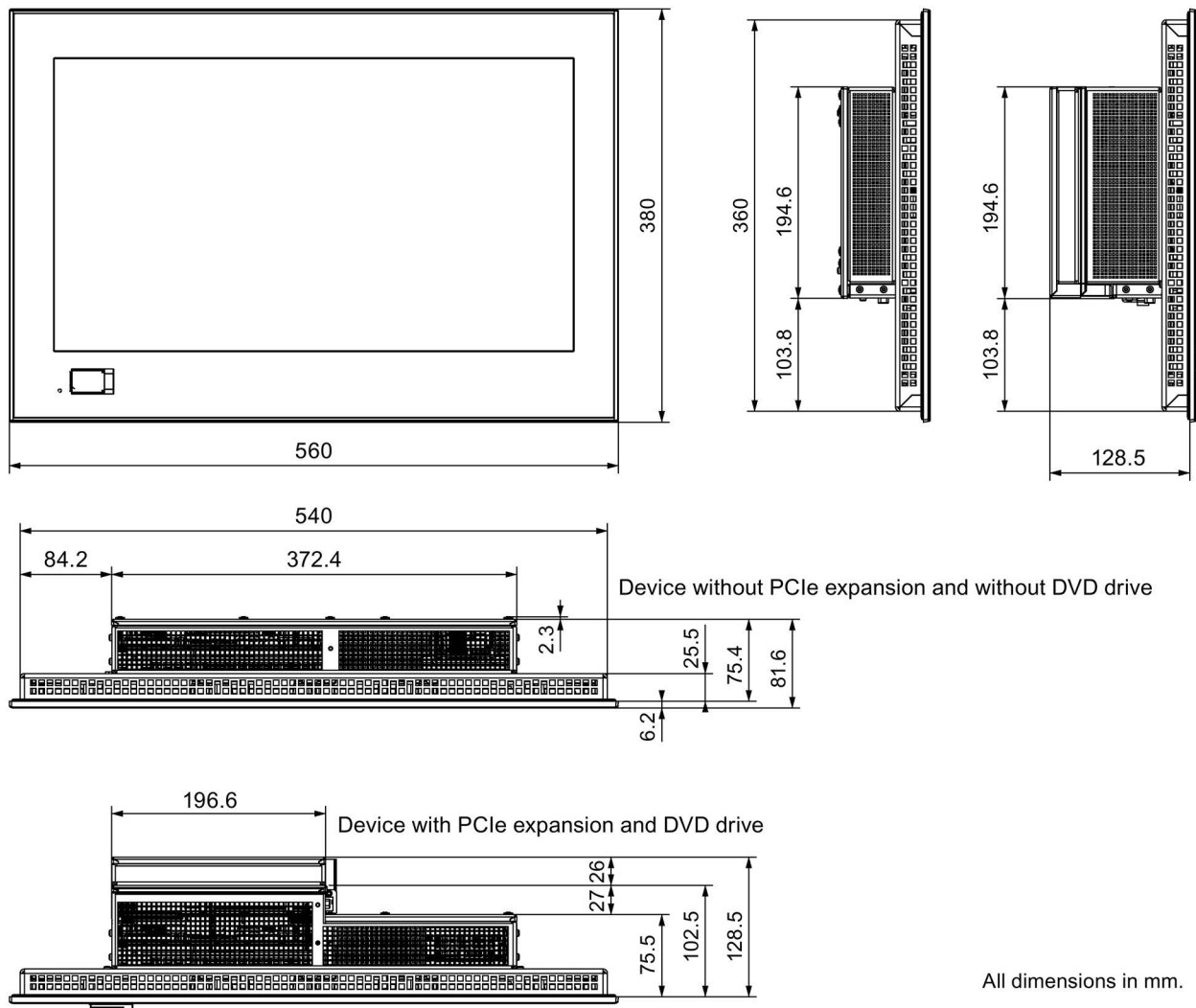

Device depths

- Without expansion cards: 75.5 mm
- With DVD drive: 101.5 mm
- With PCIe card: 102.5 mm
- With DVD drive and PCIe card: 128.5 mm

8.3.9 Dimension drawing of 15" touch/key device with resistive single-touch screen

The figure shows the front view and directly associated side view and top view of a device without PCI expansion and DVD drive. The side view and top view of a device with PCI expansion and DVD drive are shown beyond at a distance.

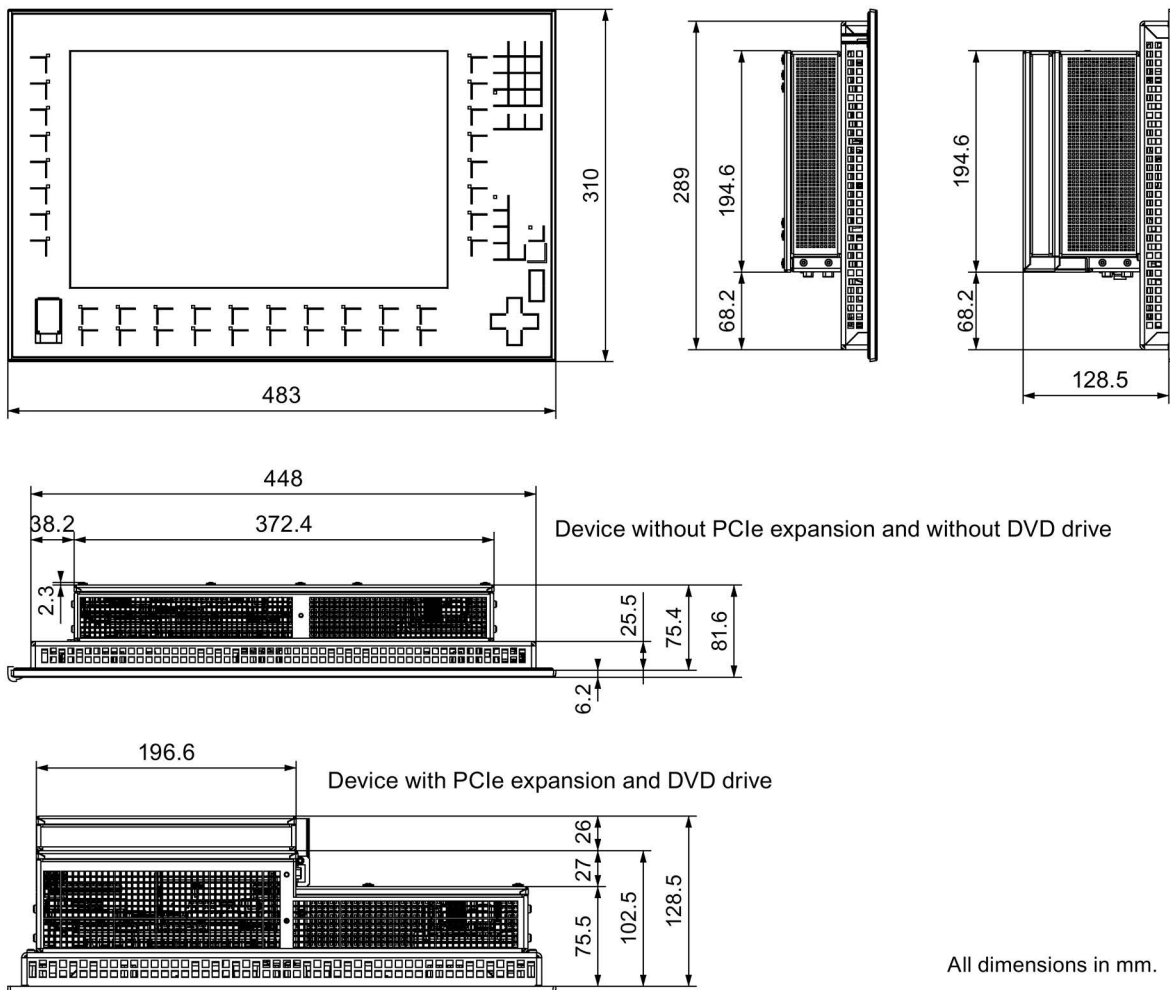

Device depths

- Without expansion cards: 75.5 mm
- With DVD drive: 101.5 mm
- With PCIe card: 102.5 mm
- With DVD drive and PCIe card: 128.5 mm

8.3.10 Dimension drawing of labeling strips

This section contains the dimensions of the labeling strips for the touch/key variant of the built-in unit with 15" display. You will find labeling strip templates with a scale of 1:1 as a Word file:

- On the Internet at:
Labeling strips for 15" widescreen
(<http://support.automation.siemens.com/DE/view/en/59000814>)
- In the "Support" folder on the WinCC installation DVD

Dimensions for labeling strips of 15" display

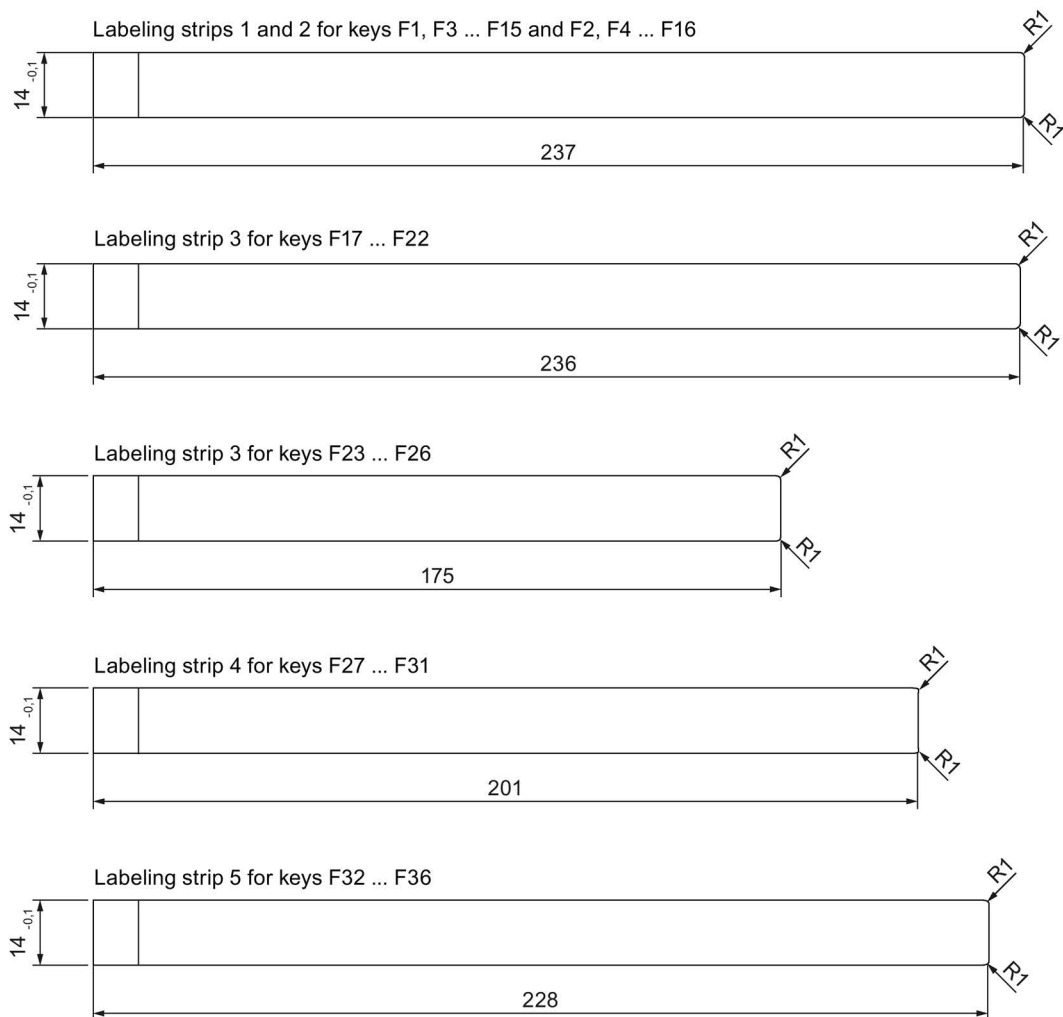

8.4 Technical specifications

8.4.1 Built-in unit

8.4.1.1 General technical specifications

Weight of touch device (without expansions): <ul style="list-style-type: none"> • Touch device, 12" display • Touch screen device, 15" display • Touch screen device, 19" display • Touch screen device, 22" display Weight of touch/key device (without expansions): <ul style="list-style-type: none"> • Touch/key device, 15" display 	resistive touch screen <ul style="list-style-type: none"> • Approximately 3200 g • Approximately 4920 g • Approximately 6400 g • Approximately 7000 g • Approximately 5750 g	capacitive touch screen <ul style="list-style-type: none"> • - • Approximately 5200 g • Approximately 6700 g • Approximately 7200 g • -
For device with expansion cards, the weight increases accordingly: <ul style="list-style-type: none"> • Expansion: PCIe card • Expansion: DVD drive • Expansion: PCIe card and DVD drive 	<ul style="list-style-type: none"> • Approximately 150 g • Approximately 420 g • Approximately 580 g 	
Power supply ¹	<ul style="list-style-type: none"> • 24 V DC (-20 % / +20 %) ¹ • 100-240 VAC (-15 % / +20 %); 50-60 Hz 	
Short-term voltage interruption according to Namur	Min. 20 ms (DC) Min. 20 ms (AC); max. 10 events per hour; min. 1 s recovery time	
Degree of protection	<ul style="list-style-type: none"> • IP 20 to IEC 60529 (enclosure) • IP 65 (front) 	
Quality assurance	In accordance with ISO 9001	

¹ The generation of the supply voltage by the line-side power supply must be realized as safety extra-low voltage with safe electrical isolation, isolated according to IEC 60364-4-41 or as SELV according to IEC/UL/EN/DIN-EN 60950-1. The supplying source must be fused for a power rating < 240 VA; recommended fuse rating ≤ 8 A.

Power consumption (DC)

The table below shows the maximum power consumption of the devices with and without expansions, depending on the processor.

Device type	Intel Celeron processor		Intel Core i3 processor		Intel Core i7 processor	
	Without expansion	With PCIe and DVD	Without expansion	With PCIe and DVD	Without expansion	With PCIe and DVD
12" Touch	53 W	67 W	58 W	72 W	59 W	73 W
15" Touch	61 W	75 W	67 W	80 W	68 W	82 W
15" Touch/Key	61 W	75 W	67 W	80 W	68 W	83 W
19" Touch	59 W	73 W	64 W	78 W	66 W	80 W
22" Touch	67 W	80 W	72 W	86 W	74 W	88 W

The values are determined under the following test conditions:

- 24 V DC supply voltage
- Internal storage media:
 - One SSD
 - Two CFast cards
- External storage media: 4 x USB 3.0, maximum 2 high-current
- 2 active LAN interfaces
- Simulated loads for devices with expansions:
 - 5 W PCIe
 - 7.5 W DVD
- BIOS setting: High Performance
- "Dim" setting with SetBrightness: 100 %

Electromagnetic compatibility

Interference emission	EN 61000-6-4; CISPR 22 Class A; FCC Class A
Immunity with regard to conducted interference on the supply lines	± 2 kV according to IEC 61000-4-4; burst ± 1 kV according to IEC 61000-4-5; symmetrical surge ± 2 kV according to IEC 61000-4-5; asymmetrical surge
Noise immunity on signal lines	± 2 kV according to IEC 61000-4-4; Burst; Length > 3 m ± 1 kV according to IEC 61000-4-4; Burst; length < 3 m ± 2 kV according to IEC 61000-4-5; Surge, symmetric, length > 30 m
Immunity to electrostatic discharge	± 6 kV contact discharge at the front according to IEC 61000-4-2 ± 4 kV, housing contact discharge at the back according to IEC 61000-4-2 ± 8 kV air discharge according to IEC 61000-4-2
Immunity to RF interference	10 V/m, 80 to 2000 MHz 80% AM according to IEC 61000-4-3 3 V/m, 2 to 2.7 GHz 10 V, 10 kHz to 80 MHz according to IEC 61000-4-6
Immunity to magnetic fields	100 A/m, 50/60 Hz according to IEC 61000-4-8

Motherboard

Depending on the device variants, the device features the following components:

Processor	<ul style="list-style-type: none"> • Intel Celeron 827E 1.4 GHz; 1.5 MB SLC or • Intel Core i3-3217UE 1.6 GHz; 3 MB SLC or • Intel Core i7-3517UE 1.7 GHz; 4 MB SLC
Main memory	<ul style="list-style-type: none"> • SO-DIMM modules; 1024 MB DDR3-SDRAM or • SO-DIMM modules; 2048 MB DDR3-SDRAM or • SO-DIMM modules; 4096 MB DDR3-SDRAM or • SO-DIMM modules; 8192 MB DDR3-SDRAM
Backup memory ¹	512 KB MRAM

¹ For devices with retentivity

Drive and memory media

Depending on the device variants, the device features the following components:

SATA drive	1 slot
Solid State Drive	1 × ≥ 80 GB; 2.5" SATA SSD
Hard disk drive, HDD	1 × ≥ 250 GB, 2.5" SATA HDD
CFast card	2 GB or 4 GB or 8 GB or 16 GB
DVD drive, RW	1 slot with expansion

Display

	12"	15" ¹	15.6" ²	19"	22"
Display type	LCD TFT with extended viewing angle		LCD TFT	LCD TFT	LCD TFT with extended viewing angle
Active display area	261 x 163 mm	331 x 207 mm	364 x 216 mm	410 x 230 mm	475 x 267 mm
Resolution	1280 x 800 pixels		1366 x 768 pixels	1366 x 768 pixels	1920 x 1080 pixels
Possible colors	Up to 16.7 million				
Brightness control	Yes, from 0 to 99 ³ , 0 = backlighting off				
Backlighting	LED		LED	LED	LED
Half Brightness Life Time (MTBF ^{3,4})	80000 h		70000 h	50000 h	30000 h
Pixel error class in accordance with ISO 9241-307	I				
Touch force resistive touch screen	With test pen, 2 mm diameter: 5 N				

8.4 Technical specifications

	12"	15" ¹	15.6" ²	19"	22"
Graphics					
Graphics controller	Intel HD 2000 or Intel HD 4000				
Graphics memory	32 to 512 MB shared memory				
External interfaces	<ul style="list-style-type: none"> DVI-I: 640 × 480 ... 1920 × 1200, 60 Hz DP (DisplayPort): 1920 × 1200, 60 Hz 				

- 1 with resistive touch screens only
- 2) with capacitive touch screens only
- 3 Via SetBrightness dialog: 9 to 99 (± 10 to 100%),
via SetBrightness command line call: 0 to 99
- 4 MTBF: Operating hours after which the maximum brightness is reduced by half compared to the original value. MTBF is increased by using the integrated dimming function, for example, time-controlled via screen saver or centrally via PROFlenergy.

Interfaces

COM 1 and COM 2	RS 232, max. 115 kbps, 9-pin, D-sub connector
DVI	Connection of display devices with DVI connection
Display port (DPP)	Connection of display devices with DPP connection
Keyboard	Connection via USB port
Mouse	Connection via USB port
USB	Back of device: <ul style="list-style-type: none"> 4 x USB 3.0, a maximum of 2 can be operated in high-current mode at the same time Front of device (only for devices with resistive touch screen with 15", 19" and 22" display): <ul style="list-style-type: none"> 1 x USB 2.0, high current
PROFIBUS/MPI	9-pin, 2-row, electrically isolated, D-sub socket, CP 5622 compatible
<ul style="list-style-type: none"> Transmission rate Operating modes 	<ul style="list-style-type: none"> 9.6 kbps to 12 Mbps DP master: DP-V0, DP-V1 with SOFTNET-DP DP slave: DP-V0, DP-V1 with SOFTNET-DP slave
PROFINET	3 x RJ45 connection, CP 1616-compatible onboard port based on ERTEC 400 10/100 Mbps, electrically isolated
Ethernet ¹	2 x RJ45 connection, Intel 82579LM and Intel 82574L 10/100/1000 Mbps, electrically isolated, teaming-capable ² or For PROFINET variants: 1 x Ethernet RJ45, Intel 82579LM
Slot for PCIe expansion cards	Only for device with expansions: <ul style="list-style-type: none"> 1 x PCIe-x4 expansion card can be used Max. permissible power loss: 5 W

- 1 For unique labeling, the Ethernet ports are numbered on the enclosure. The numbering by the operating system can differ.
- 2 Teaming can be set and initiated in the configuration interface. In teaming operation, jumbo frames, e.g. for the camera application, are not supported.

8.4.1.2 Environmental conditions

Climatic ambient conditions

Maximum permitted ambient temperature during operation			
Temperature, tested according to IEC 60068-2-1, IEC 60068-2-2			
Touch devices			
All touch devices	Temperature during storage/transport Storage/transport, gradient	-20 °C to +60 °C Max. 20 °C/h, no condensation	
12" display	At an ambient temperature > 45 °C, the device must be operated in an operating area in accordance with RAL.		
	When installed vertically in horizontal format	With SSD: With CFast:	+0 to +50 °C +0 to +50 °C
	When installed inclined in horizontal format, Vertical inclination max. ± 45°	With SSD: With CFast:	+0 to +50 °C +0 to +50 °C
	When installed upright in vertical format, Display rotated 90° vertical from the standard position (Power supply is located at the top)	With SSD: With CFast:	+0 to +40 °C +0 to +40 °C
15" display	At an ambient temperature > 45 °C, the device must be operated in an operating area in accordance with RAL.		
	When installed vertically in horizontal format	With HDD: With SSD: With CFast:	+5 to +35 °C +0 to +50 °C +0 to +50 °C
	When installed inclined in horizontal format, Vertical inclination max. ± 45°	With HDD: With SSD: With CFast:	+5 to +35 °C +0 to +50 °C +0 to +50 °C
	When installed upright in vertical format, Display rotated 90° vertical from the standard position (Power supply is located at the top)	With HDD: With SSD: With CFast:	+5 to +35 °C +0 to +40 °C +0 to +40 °C
19" display			
	When installed vertically in horizontal format	With HDD: With SSD: With CFast:	+5 to +40 °C +0 to +45 °C +0 to +45 °C
	When installed inclined in horizontal format, Vertical inclination max. ± 45°	With HDD: With SSD: With CFast:	+5 to +35 °C +0 to +40 °C +0 to +40 °C
	When installed upright in vertical format, Display rotated 90° vertical from the standard position (Power supply is located at the top)	With HDD: With SSD: With CFast:	+5 to +35 °C +0 to +40 °C +0 to +40 °C
22" display			
	When installed vertically in horizontal format	With HDD: With SSD: With CFast:	+5 to +40 °C +0 to +45 °C +0 to +45 °C

8.4 Technical specifications

	When installed inclined in horizontal format, Vertical inclination max. $\pm 45^\circ$	With HDD: With SSD: With CFast:	+5 to +35 °C +0 to +40 °C +0 to +40 °C
	When installed upright in vertical format, Display rotated 90° vertical from the standard position (Power supply is located at the top)	With HDD: With SSD: With CFast:	+5 to +35 °C +0 to +40 °C +0 to +40 °C
Touch/key devices			
All touch/key devices	Temperature during storage/transport Storage/transport, gradient	-20 °C to +60 °C Max. 20 °C/h, no condensation	
(15" display)	At an ambient temperature > 45 °C, the device must be operated in an operating area in accordance with RAL.		
	When installed vertically in horizontal format	With HDD: With SSD: With CFast:	+5 to +35 °C +0 to +50 °C +0 to +50 °C
	When installed inclined in horizontal format, Vertical inclination max. $\pm 45^\circ$	With HDD: With SSD: With CFast:	+5 to +35 °C +0 to +50 °C +0 to +50 °C
	When installed upright in vertical format, Display rotated 90° vertical from the standard position (Power supply is located at the top)	With HDD: With SSD: With CFast:	+5 to +35 °C +0 to +40 °C +0 to +40 °C

Note

Ambient temperature with DVD operation

For a device with DVD drive for drive operation:

- Reading up to max. 40 °C ambient temperature at the device
- Writing up to max. 35 °C ambient temperature at the device

Relative humidity, tested in accordance with IEC 60068-2-78, IEC 60068-2-30	
Operation	5 ... 85% at 30 °C, no condensation
Storage/transport	5 to 95 % at 25/55 °C, no condensation
Air pressure, in accordance with IEC 60068-2-13	
Operation	1080 hPa to 795 hPa, corresponds to an elevation of 1000 m to 2000 m
Storage/transport	1080 hPa to 660 hPa, corresponds to an elevation of 1000 m to 3500 m

Protection against foreign objects and water

Degree of protection	Explanation
Front	When mounted: <ul style="list-style-type: none"> • IP65 according to IEC 60529 • Front face only Type 4X/Type 12 (indoor use only) according to UL50
Rear panel	IP20 Touch protection test with standard test probes. There is no protection against ingress by water.

The degree of protection of the device front can only be guaranteed if the mounting seal is intact and lies flush against the mounting cutout.

Mechanical ambient conditions

Vibration, tested according to DIN IEC 60068-2-6	
Operation with HDD	10 Hz to 58 Hz: 0.375 mm 58 Hz to 200 Hz: 4.9 m/s ²
Operation with CFast and SSD	5 Hz to 8.4 Hz: 3.5 mm 8.4 Hz to 500 Hz: 9.8 m/s ²
Storage/transport	5 to 8.4 Hz: 3.5 mm 8.4 Hz to 500 Hz: 9.8 m/s ²
Shock resistance, tested in accordance with IEC 60068-2-27, IEC 60068-2-29	
Operation	50 m/s ² , 30 ms
Storage/transport	250 m/s ² , 6 ms

Note

Vibration load with DVD operation

For a device with DVD drive for drive operation: The maximum permitted vibration load of the device is 0 m/s².

See also

Permitted mounting positions (Page 38)

8.4.2 PRO device

8.4.2.1 General specifications PRO device

Weight PRO device: • 19" display	• 7.9 kg
Power supply ¹	• 24 V DC (-20 % / +20 %) ¹
Short-term voltage interruption according to Namur	Min. 20 ms (DC) Min. 20 ms (AC); max. 10 events per hour; min. 1 s recovery time
Degree of protection	• IP 65 (all-round) • Enclosure Type 4X / 12 (indoor use only)
Quality assurance	In accordance with ISO 9001

¹ The generation of the supply voltage by the line-side power supply must be realized as safety extra-low voltage with safe electrical isolation, isolated according to IEC 60364-4-41 or as SELV according to IEC/UL/EN/DIN-EN 60950-1. The power supply must meet the requirement NEC Class 2 or LPS according to the standard IEC/EN/DINEN/UL 60950-1 60950-1.

Power consumption (DC)

The table below shows the maximum power consumption of PRO devices depending on the processor.

Device type	Intel Celeron processor	Intel Core i3 processor	Intel Core i7 processor
19" Touch	59 W	64 W	66 W

The values are determined under the following test conditions:

- 24 V DC supply voltage
- Internal storage media:
 - One SSD
 - Two CFAST cards
- External storage media: 4 x USB 3.0, maximum 1 high-current
- 2 active LAN interfaces
- BIOS setting: High Performance
- "Dim" setting with SetBrightness: 100 %

Electromagnetic compatibility

Interference emission	EN 61000-6-4; CISPR 22 Class A; FCC Class A
Immunity with regard to conducted interference on the supply lines	± 2 kV according to IEC 61000-4-4; burst ± 1 kV according to IEC 61000-4-5; symmetrical surge ± 2 kV according to IEC 61000-4-5; asymmetrical surge
Noise immunity on signal lines	± 2 kV according to IEC 61000-4-4; Burst; Length > 3 m ± 1 kV according to IEC 61000-4-4; Burst; length < 3 m ± 2 kV according to IEC 61000-4-5; Surge, symmetric, length > 30 m
Immunity to electrostatic discharge	± 6 kV contact discharge in accordance with IEC 61000-4-2 ± 8 kV air discharge in accordance with IEC 61000-4-2
Immunity to RF interference	10 V/m, 80 to 2000 MHz 80% AM according to IEC 61000-4-3 3 V/m, 2 to 2.7 GHz 10 V, 10 kHz to 80 MHz according to IEC 61000-4-6
Immunity to magnetic fields	100 A/m, 50/60 Hz according to IEC 61000-4-8

Motherboard

Depending on the device variants, the device features the following components:

Processor	<ul style="list-style-type: none"> • Intel Celeron 827E 1.4 GHz; 1.5 MB SLC or • Intel Core i3-3217UE 1.6 GHz; 3 MB SLC or • Intel Core i7-3517UE 1.7 GHz; 4 MB SLC
Main memory	<ul style="list-style-type: none"> • SO-DIMM modules; 1024 MB DDR3-SDRAM or • SO-DIMM modules; 2048 MB DDR3-SDRAM or • SO-DIMM modules; 4096 MB DDR3-SDRAM or • SO-DIMM modules; 8192 MB DDR3-SDRAM
Backup memory ¹	512 KB MRAM

¹ For devices with retentivity

Drive and memory media

Depending on the device variants, the device features the following components:

SATA drive	1 slot
Solid State Drive	1 × ≥ 80 GB; 2.5" SATA SSD
CFast card	2 GB or 4 GB or 8 GB or 16 GB

Display

	19"
Display type	LCD TFT
Active display area	410 x 230 mm
Resolution	1366 x 768 pixels
Possible colors	Up to 16.7 million
Brightness control	Yes, from 0 to 99 ³ , 0 = backlighting off
Backlighting	LED
Half Brightness Life Time (MTBF ^{3 4})	50000 h
Pixel error class in accordance with ISO 9241-307	I
Touch force resistive touch screen	With test pen, 2 mm diameter: 5 N
Graphics	
Graphics controller	Intel HD 2000 or Intel HD 4000
Graphics memory	32 to 512 MB shared memory
External interfaces	<ul style="list-style-type: none"> • DVI-I: 640 × 480 ... 1920 × 1200, 60 Hz • DP (DisplayPort): 1920 × 1200, 60 Hz

³ Via SetBrightness dialog: 9 to 99 (± 10 to 100%),
via SetBrightness command line call: 0 to 99

⁴ MTBF: Operating hours after which the maximum brightness is reduced by half compared to the original value. MTBF is increased by using the integrated dimming function, for example, time-controlled via screen saver or centrally via PROFIenergy.

Interfaces

COM 1	RS 232, max. 115 kbps, 9-pin, D-sub connector
DVI	Connection of display devices with DVI connection
Display port (DPP)	Connection of display devices with DPP connection
Keyboard	Connection via USB port
Mouse	Connection via USB port
USB	Back of device: <ul style="list-style-type: none"> • 4 × USB 3.0 • Max. 1 high-current can be operated at the same time • Max. 5 W for all USB devices
PROFIBUS/MPI <ul style="list-style-type: none"> • Transmission rate • Operating modes 	9-pin, 2-row, electrically isolated, D-sub socket, CP 5622 compatible <ul style="list-style-type: none"> • 9.6 kbps to 12 Mbps • DP master: DP-V0, DP-V1 with SOFTNET-DP • DP slave: DP-V0, DP-V1 with SOFTNET-DP slave
Ethernet ¹	2 x RJ45 connection, Intel 82579LM and Intel 82574L 10/100/1000 Mbps, electrically isolated, teaming-capable ²

¹ For unique labeling, the Ethernet ports are numbered on the enclosure. The numbering by the operating system can differ.

² Teaming can be set and initiated in the configuration interface. In teaming operation, jumbo frames, e.g. for the camera application, are not supported.

8.4.2.2 Ambient conditions PRO device

Climatic ambient conditions

Maximum permitted ambient temperature during operation			
Temperature, tested according to IEC 60068-2-1, IEC 60068-2-2			
Touch devices			
19" display	Temperature during storage/transport	-20 °C to +60 °C	
	Storage/transport, gradient	Max. 20 °C/h, no condensation	
19" display with Intel Celeron processor			
	all mounting positions ¹	With SSD:	+0 to +45 °C
		CFast only:	+0 to +45 °C
19" display with Intel i3- or i7 processor			
	all mounting positions ¹	With SSD:	+0 to +40 °C
		CFast only:	+0 to +45 °C

¹ See "Permissible mounting positions" in the section "Installing and connecting the device", "Preparing installation", "PRO device".

Relative humidity, tested in accordance with IEC 60068-2-78, IEC 60068-2-30	
Operation	5 ... 85% at 30 °C, no condensation
Storage/transport	5 to 95 % at 25/55 °C, no condensation
Air pressure, in accordance with IEC 60068-2-13	
Operation	1080 hPa to 795 hPa, corresponds to an elevation of 1000 m to 2000 m
Storage/transport	1080 hPa to 660 hPa, corresponds to an elevation of 1000 m to 3500 m

Mechanical ambient conditions

Vibration, tested according to DIN IEC 60068-2-6	
Operation with CFast and SSD	5 Hz to 8.4 Hz: 3.5 mm
	8.4 Hz to 500 Hz: 9.8 m/s ²
Storage/transport	5 to 8.4 Hz: 3.5 mm
	8.4 Hz to 500 Hz: 9.8 m/s ²
Shock resistance, tested in accordance with IEC 60068-2-27, IEC 60068-2-29	
Operation	50 m/s ² , 30 ms
Storage/transport	250 m/s ² , 6 ms

8.4.2.3 Information on insulation tests, protection class and degree of protection

Test voltages

Insulation resistance is demonstrated in the type test with the following test voltages in accordance with IEC 61131-2:

Circuits with a nominal voltage of U_n to other circuits or ground	Test voltage
< 50 V	500 V DC

Protection class

Protection Class I in accordance with IEC 60536, i.e. PE/ground connection required.

Protection against foreign objects and water

The following degree of protection applies to the PRO device:

Device side	Degree of protection
all sides	<ul style="list-style-type: none"> • IP65 according to IEC 60529 • Enclosure Type 4X / 12 (indoor use only) according to UL50

8.4.2.4 Rated voltages

The table below shows the rated voltage and the corresponding tolerance range.

Rated voltage	Tolerance range
+24 VDC	19.2 to 28.8 V (+/-20%)

8.4.3 Power requirements of the components

Maximum power consumption of the auxiliary components

Auxiliary components		Maximum permitted power consumption			Max. total power
		+5 V	+3.3 V	+12 V	
USB device ¹	High current	1 A	-	-	Built-in unit: 10 W for all USB devices PRO device: 5 W for all USB devices
PCIe modules ^{1 2}	Per slot	-	1.5 A	0.5 A	5 W for the whole device
PROFIBUS		500 mA	-	-	

¹ The total power for PCIe ² and USB expansions may not exceed 15 W

² Not for PRO device, for built-in unit only

Note

Built-in unit may overheat!

For thermal reasons, the power loss of the PCIe expansion card may not exceed 5 W with built-in units.

8.4.4 Integrated DC power supply

Input voltage	24 V DC (-20%/+20%)
Power consumption ¹	Max. 90 W
Power failure buffering	Hold-up time ≥ 20 ms with 20.4 V (DC_FAIL is active after > 5 ms)
Efficiency	>85 %

¹ Power consumption depends on device configuration. The specified power consumption relates to the maximum device configuration.

Note

Inrush current

At least 5 A inrush current for 15 ms is required for device startup.

The peak value of the starting current depends on the input voltage and the impedance of the 24 V DC power supply. Peak currents greater than 6.5 A are possible. This will not have a negative impact on device functionality.

8.4.5 AC voltage supply

Input voltage	100-240 VAC (-15 % / +20 %); 50-60 Hz
Power consumption ¹	Max. 90 W
Power failure buffering	"AC FAIL" becomes active after ≥ 20 ms, The power supply continues to buffer for ≥ 20 ms at ≥ 93 V
Efficiency	>85 %

¹ Power consumption depends on device configuration. The specified power consumption relates to the maximum device configuration.

Note

Inrush current

The power consumption of the device is dependent on the device configuration and can be up to 1.1 A.

The peak value of the starting current depends on the input voltage and the impedance of the power supply, and can be up to 50 A for < 1 ms. This will not have a negative impact on device functionality.

8.5 Hardware descriptions

8.5.1 External ports

8.5.1.1 COM1/COM2

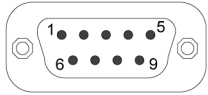
Serial port COM1, 9-pin (plug) or COM2			
			
Pin no.	Short description	Meaning	Input / output
1	DCD	Data carrier detect	Input
2	RxD	Received data	Input
3	TxD	Transmit data	Output
4	DTR	Data terminal ready	Output
5	GND	Ground	-
6	DSR	Ready for operation	Input
7	RTS	Request to send	Output
8	CTS	Clear to send	Input
9	RI	Incoming call	Input

8.5.1.2 CFast

Pin no.	Short name	Meaning
S1	SGND	Signal GND (ground for signal integrity)
S2	A+	SATA differential
S3	A-	SATA differential
S4	SGND	Signal GND (ground for signal integrity)
S5	B-	SATA differential
S6	B+	SATA differential
S7	SGND	Signal GND (ground for signal integrity)
PC1	CDI	Card Detect In
PC2	GND	Device GND
PC3	TBD	TBD (not connected)
PC4	TBD	TBD (not connected)
PC5	TBD	TBD (not connected)
PC6	TBD	TBD (not connected)
PC7	GND	Device GND
PC8	LED1	LED Output (not connected)

Pin no.	Short name	Meaning
PC9	LED2	LED Output (not connected)
PC10	IO1	Reserved Input/Output (not connected)
PC11	IO2	Reserved Input/Output (not connected)
PC12	IO3	Reserved Input/Output (not connected)
PC13	PWR	Device Power (3.3V)
PC14	PWR	Device Power (3.3V)
PC15	GND	Device GND
PC16	GND	Device GND
PC17	CDO	Card Detect Out

8.5.1.3 DisplayPort

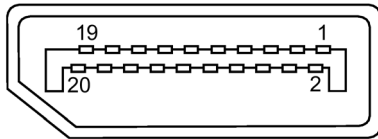

Pin no.	Short name	Meaning	Input / output
1	ML_Lane0+	DP data 0+	Output
2	GND	Ground	-
3	ML_Lane0-	DP data 0-	Output
4	ML_Lane1+	DP data 1+	Output
5	GND	Ground	-
6	ML_Lane1-	DP data 1-	Output
7	ML_Lane2+	DP data 2+	Output
8	GND	Ground	-
9	ML_Lane2-	DP data 2-	Output
10	ML_Lane3+	DP data 3+	Output
11	GND	Ground	-
12	ML_Lane3-	DP data 3-	Output
13	CONFIG1 CAD	Cable Adapter Detect	Input
14	CONFIG2	Ground (PullDown)	-
15	AUX_CH+	Auxiliary channel+	Bidirectional
16	GND	Ground	-
17	AUX_CH-	Auxiliary channel-	Bidirectional
18	HPD	Hot Plug Detect	Input
19	GND	Ground	-
20	DP_PWR	+3.3V (fused)	Output

8.5.1.4 DVI-I

DVI-I port (standard socket)			
Pin no.	Short description	Meaning	Input / output
1	TMDS Data2-	DVI data channel	Output
2	TMDS Data2+	DVI data channel	Output
3	TMDS Data2/4 shield	Cable shield	
4	NC		
5	NC		
6	DDC clock (SCL)	Display Data Channel – Clock	Input / output
7	DDC data (SDA)	Display Data Channel – Data	Input / output
8	Analog vertical sync (VSYNC)	Analog Vertical Sync Signal	Output
9	TMDS Data1-	DVI data channel	Output
10	TMDS Data1+	DVI data channel	Output
11	TMDS Data1/3 shield	Cable shield	
12	NC		
13	NC		
14	+5V power (VCC)	+5V power for DCC	Output
15	Ground (return for +5V, Hsync and Vsync) (GND)	Analog ground	
16	Hot Plug Detect		
17	TMDS data 0-	DVI data channel	Output
18	TMDS data 0+	DVI data channel	Output
19	TMDS Data0/5 shield	Cable shield	
20	NC		
21	NC		
22	TMDS clock shield	Cable shield	
23	TMDS clock+	DVI clock channel	Output
24	TMDS clock-	DVI clock channel	Output
C1	Analog red (R)	Analog Red Signal	Output
C2	Analog green (G)	Analog Green Signal	Output
C3	Analog blue (B)	Analog Blue Signal	Output
C4	Analog horizontal sync (HSYNC)	Analog Horizontal Sync Signal	Output
C5	Analog ground (analog R, G, & return) (GND)	Analog ground	

8.5.1.5 Ethernet

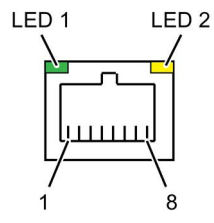
Ethernet RJ45 interface			
			
Pin no.	Short description	Meaning	Input / output
1	BI_DA+	Bi-directional data A+	Input/output
2	BI_DA-	Bi-directional data A-	Input/output
3	BI_DB+	Bi-directional data B+	Input/output
4	BI_DC+	Bi-directional data C+	Input/output
5	BI_DC-	Bi-directional data C-	Input/output
6	BI_DB-	Bi-directional data B-	Input/output
7	BI_DD+	Bi-directional data D+	Input/output
8	BI_DD-	Bi-directional data D-	Input/output
S		Shield	–
	LED 1	Off: 10 Mbps Green light: 100 Mbps Orange light: 1000 Mbps	–
	LED 2	Lit: Active connection, e.g., to a hub Flashing: Activity	–

8.5.1.6 USB 3.0 port

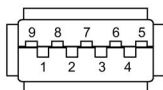

Pin no.	Short name	Meaning	Input / output
1	VBUS	+ 5 V (fused)	Output
2	D-	Data channel USB2	Input / output
3	D+	Data channel USB2	Input / output
4	GND	Ground	–
5	RX-	Data channel USB3	Input
6	RX+	Data channel USB3	Input
7	GND	Ground	–
8	TX-	Data channel USB3	Output
9	TX+	Data channel USB3	Output

8.5.1.7 USB 2.0

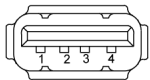
USB 2.0 port		
		
Pin no.	Short description	Meaning
1	USB_P5V_fused (O)	+ 5 V (fused) for external USB interface
2	USB_D0M (I/O)	Data-, USB channel 0
3	USB_D0P (I/O)	Data+, USB channel 0
4	USB_GND	Ground for external USB interface

8.5.1.8 PROFIBUS

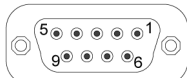
PROFIBUS interface, 9-pin (socket)		
		
Pin no.	Short description	Meaning
1-2	NC	Not connected
3	LTG_B	Data line (I/O)
4	RTS_AS	Turn on PLC transmitter (O)
5	GND	Ground isolated
6	P5V_dp_fused	+5 V / max. 90 mA (fused) electrically isolated
7	NC	Not connected
8	LTG_A	Data line (I/O)
9	RTS_PG	PG Request to send (O)

8.5.1.9 PROFINET

PROFINET LAN X3 Port P1, P2, P3

PROFINET interface			
Pin no.	Short description	Meaning	Input / output
1	RD+	Receive data ²	Input
2	RD-	Receive data ²	Input
3	TD+	Send data ²	Output
4, 5 ¹	SYMR	Internal 75 Ohm terminating resistor	–
6	TD-	Receive data ²	Output
7, 8 ¹	SYMT-	Internal 75 Ohm terminating resistor	–
S		Shield	
	LED 1	Lights up green: link	
	LED 2	Lights up yellow: Activity	

¹ Optional product variant

² Auto Negotiation and auto crossover are supported

8.5.2 Internal ports

8.5.2.1 PCIe card

Pin assignment for the PCIe-x4 card interface				
Pin no.	Side B		Side A	
	Name	Description	Name	Description
1	+12 V	12 V power	PRSNT1#	Hot-plug presence detect
2	+12 V	12 V power	+12 V	12 V power
3	+12 V	12 V power	+12 V	12 V power
4	GND	Ground	GND	Ground
5	SMCLK	SMBUS (System Management Bus) clock	JTAG2	TCK (Test Clock), clock input for JTAG interface (not connected)
6	SMDAT	SMBus (System Management Bus) data	JTAG3	TDI (Test Data Input) (not connected)
7	GND	Ground	JTAG4	TDO (Test Data Output) (not connected)

Pin assignment for the PCIe-x4 card interface				
8	+3.3 V	3.3 V power	JTAG5	TMS (Test Mode Select) (not connected)
9	JTAG1	TRST# (Test Reset) resets the JTAG interface (not connected)	+3.3 V	3.3 V power
10	3.3 Vaux	3.3 V auxiliary power	+3.3 V	3.3 V power
11	WAKE#	Signal for link reactivation	PERST#	Fundamental reset
12	RSVD	Reserved	GND	Ground
13	GND	Ground	REFCLK+	Reference clock (differ- ential pair)
14	PETp0	Transmitter differential pair, Lane 0	REFCLK-	Reference clock (differ- ential pair)
15	PETn0	Transmitter differential pair, Lane 0	GND	Ground
16	GND	Ground	PERp0	Receiver differential pair, Lane 0
17	PRSNT2#	Hot-plug presence detect (not connected)	PERn0	Receiver differential pair, Lane 0
18	GND	Ground	GND	Ground
19	PETp1	Transmitter differential pair, Lane1	RSVD	Reserved
20	PETn1	Transmitter differential pair, Lane1	GND	Ground
21	GND	Ground	PERp1	Receiver differential pair, Lane1
22	GND	Ground	PERn1	Receiver differential pair, Lane1
23	PETp2	Transmitter differential pair, Lane2	GND	Ground
24	PETn2	Transmitter differential pair, Lane2	GND	Ground
25	GND	Ground	PERp2	Receiver differential pair, Lane2
26	GND	Ground	PERn2	Receiver differential pair, Lane2
27	PETp3	Transmitter differential pair, Lane3	GND	Ground
28	PETn3	Transmitter differential pair, Lane3		Ground
29	GND	Ground	PERp3	Receiver differential pair, Lane3
30	RSVD	Reserved	PERn3	Receiver differential pair, Lane3
31	PRSNT2#	Hot-plug presence detect	GND	Ground
32	GND	Ground	RSVD	Reserved

8.5.3 System resources

8.5.3.1 Currently allocated system resources

All system resources (hardware addresses, memory configuration, allocation of interrupts, DMA channels) are assigned dynamically by the Windows OS, depending on the hardware configuration, drivers and connected external devices. You can view the current configuration of system resources or possible conflicts with the following operating systems:

Windows Embedded Standard and Windows 7 Ultimate	Start menu "Start": Enter "msinfo32" in the search field and press "Return" to confirm.
--	---

8.5.3.2 Assignment of system resources

The following tables and images describe the system resources for the delivery state of the device.

PCIe interrupt lines

The interrupts are assigned to devices by BIOS. There are exclusive non-shared interrupts for DP12 and the first Ethernet interface.

This means that applications or realtime operating system expansions can operate these devices exclusively and with high-performance without having to share the interrupt with other devices.

Interrupt sharing in APIC mode:

Interrupt		Interrupt type
IRQ0	HPET (High Precision Event Timer), when HPET is enabled in the BIOS "Advanced" menu. System Timer, when HPET is disabled.	ISA exclusive
IRQ1	Free	
IRQ2	Interrupt controller 2	ISA exclusive
IRQ3	Com Port 2 (COM2)	ISA exclusive
IRQ4	Com Port 1 (COM1)	ISA exclusive
IRQ5	CAN (optional)	ISA exclusive (CAN)
IRQ6	Free	
IRQ7	Free	
IRQ8	System CMOS / real-time clock	ISA exclusive
IRQ9	ACPI-SCI (system control interrupt)	
IRQ10	Free	
IRQ11	Free	
IRQ12	Free	
IRQ13	Numeric data processor	ISA exclusive
IRQ14	Free	

Interrupt		Interrupt type
IRQ15	Free	
IRQ16	Graphics; PCI Express Root Port 3, 4, 8; PCI Express Root Port 2, 3 (CPU-PEG slots) connected to PCIe Riser slots	PCI shared
IRQ17	PCIe-x4 slot on Riser (1x4)	PCI exclusive
IRQ18	LAN2 (82574L Gigabit Network connection); PCIe-x1 slot on Riser (1x1)	PCI shared
IRQ19	DP12/MPI or PROFINET (optional), MRAM	PCI exclusive
IRQ20	USB EHCI controller #1; USB EHCI controller #2; USB XHCI controller	PCI shared
IRQ21	LAN1 (82579LM, Gigabit Network connection)	PCI exclusive
IRQ22	SATA controller #1; SATA controller #2	PCI shared
IRQ23	Intel Management Engine Interface; High Definition Audio Interface	PCI shared

8.5.4 I/O Address Areas

8.5.4.1 Overview of the internal module registers

The following addresses are used for the internal registers:

Addresses	Input/output unit
I/O 062h	Watchdog enable register / 066h select register (Page 168)
I/O 066h	Watchdog trigger register (Watchdog enable register bit 2=0), Watchdog trigger register (Watchdog enable register bit 2=1) (Page 167)
I/O 50Ch	Battery status register (read-only) (Page 169)

8.5.4.2 Watchdog trigger register (read only, address 066h)

Watchdog trigger register

The watchdog is triggered by a read action (address 066h) by this register. The result of the read access can be disregarded (i.e., dummy read).

8.5.4.3 Watchdog enable register / 066h select register (read/write, address 062h)

Meaning of the bits

Watchdog enable register / 066h select register (r/w address 062h)								
Bit							Meaning of the bits	
7	6	5	4	3	2	1	0	
Watchdog enable bit (WDE)								
							0	Watchdog circuit disabled
							1	Watchdog circuit enabled
Watchdog Mode								
							0	Standard
							1	Macro
066h select register selection								
							0	Reserved
							1	
Scaler watchdog time (Normal/Macro)								
		0	0	0				94 ms / 2 s (default)
		0	0	1				210 ms / 4 s
		0	1	0				340 ms / 6 s
		0	1	1				460 ms / 8 s
		1	0	0				590 ms / 16 s
		1	0	1				710 ms / 32 s
		1	1	0				840 ms / 48 s
		1	1	1				960 ms / 64 s
Trigger red Watchdog LED								
	0							Red LED (WD) off
	1							Red LED (WD) on
Watchdog error / Display and reset								
0								WD inactive
1								WD triggered Reset LED after watchdog alarm (Bit 7 = write 1)

8.5.4.4 Battery status register (read-only, address 50Ch)

The status of the CMOS battery is monitored; the status (two-tier) can be read from the battery status register.

Meaning of the bits

Battery status register (read-only, address 404Dh)								
Bit								Meaning
7	6	5	4	3	2	1	0	
0	0							CMOS battery capacity is still sufficient.
0	1							CMOS battery capacity is exhausted (remaining capacity is sufficient for approx. one month)
1	1							CMOS battery is empty

8.5.4.5 MRAM address register

MRAM occupies a 512 KB memory address area that can be read via PCI registers.

Meaning of the bits

MRAM address register		
PCI register address: MRAM base address register	PCI register content: MRAM memory address (default)	Length of the memory area
C2B0 0000	Address is assigned dynamically (depending on device configuration)	80000 h

8.5.5 CP 1616 onboard communications processor

8.5.5.1 Introduction

Typical Communication Partners

CP 1616 onboard as an IO controller

The following diagram shows a typical application: CP 1616 onboard as PROFINET IO controller on the IO controller layer.

The IO base controller user program runs on the PC. This program accesses the functions of the IO base user program interface.

Data traffic is routed via the communication processor to several SIMATIC S7 PROFINET IO devices, ET 200S over Industrial Ethernet.

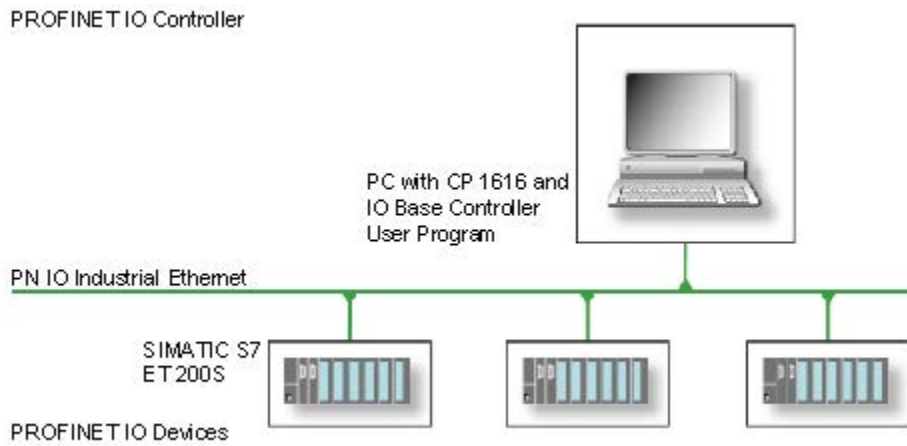

CP 1616 onboard as IO device

The following diagram shows a typical application: Two PCs each with a CP as a PROFINET IO device on the IO device layer.

A PC with a CP as PROFINET IO controller, a SIMATIC S7-400 with a CP 443-1 as PROFINET IO controller and two SIMATIC S7 ET 200S PROFINET IO devices are also connected in the network.

The IO base device user program runs on the IO device PC. This program accesses the functions of the IO base user program interface. Data traffic is routed via the CP 1616 onboard communication processor to a PC as PROFINET IO controller, or to an S7-400 automation system with CP 443-1 over Industrial Ethernet.

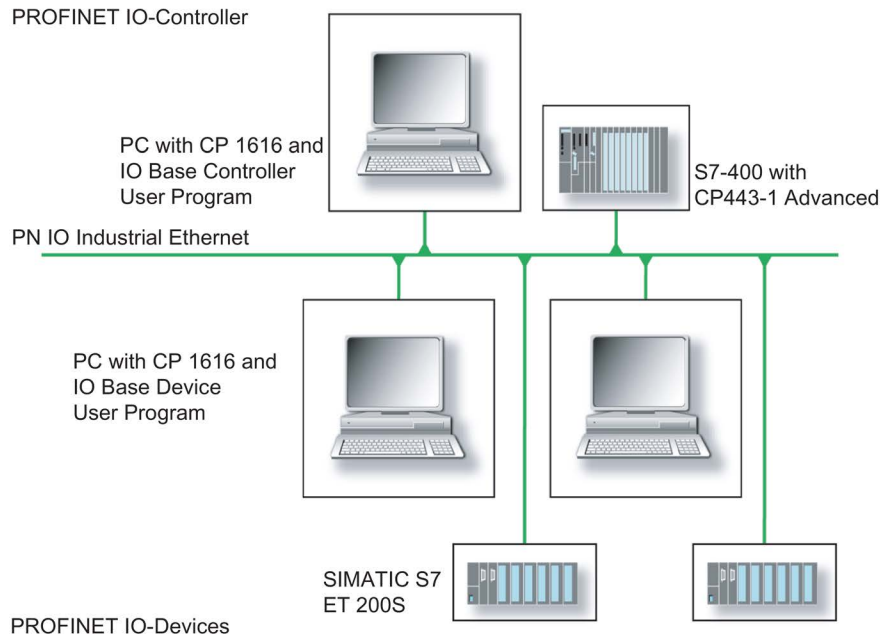

8.5.5.2 Firmware Loader

When to load firmware

The CP 1616 onboard is supplied with the latest version of the firmware. If new functions become available due to product development, you can make them available by performing a firmware download.

Description

This section will familiarize you with the application area and use of the firmware loader. You can find additional, detailed information about the individual loader variants in the integrated help of the program.

Firmware

This refers to the system program in the SIMATIC NET modules.

Application area for the firmware loader

The firmware loader enables you to reload new firmware releases to SIMATIC NET modules. It is used for:

- PROFIBUS modules
- Industrial Ethernet modules
- Modules for gateways, for example, IE/PB link

Installation

The firmware loader is available on your PG/PC under Windows following the installation of STEP 7/NCM PC.

Loader files

The firmware loader supports the following file types:

- <file>.FWL
A file form that contains further information, which is displayed by the firmware loader. The firmware loader can use this information to check if the firmware is compatible to the device.

Read the information provided along with the loader file, for example, in the readme file. This information is also displayed in the firmware loader when the FWL file is loaded.

Loading firmware

Start downloading procedure

1. In the Windows Start menu, select the menu command SIMATIC > STEP 7 > NCM S7 > Firmware Loader.

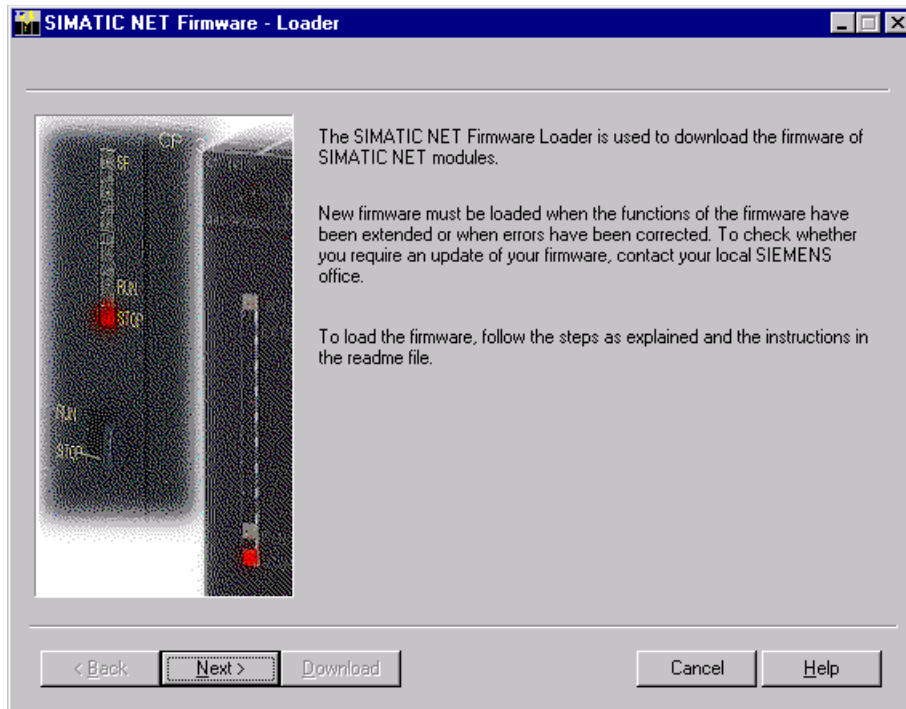

2. Click "Next" and follow the instructions in the dialog fields that follow. A help function is integrated in the software as support.

Note

Ensure that the loader file you are using for the update is suitable for the version of firmware on your module. If you have any doubts, contact your local Siemens consultant.

Note

Be aware that aborting the loading process may result in an inconsistent state in your module.

You can find additional, detailed information about the individual loader variants in the integrated help.

Note

When loading the firmware or commissioning the module, be aware that the CP 1616 onboard takes five MAC addresses (always in direct sequence). The first two addresses are displayed in the BIOS, in the "Peripheral Configuration" submenu of the "Advanced" menu.

Example

The lower MAC address at "Profinet" is provided for Layer 2 communication, while the second one is used for Ethernet/PROFINET communication.

8.5.5.3 Further actions in STEP 7/NCM PC

Configuring

Your PC is now ready, although you still have to configure the SIMATIC NET communication software. The rest of the procedure is described in the "Commissioning PC Stations" manual (on the Windows PC that also contains STEP 7/NCM PC: Start > Simatic > Documentation > English > Commissioning PC Stations).

8.6 BIOS description

8.6.1 Overview

BIOS Setup program

The BIOS Setup program, or BIOS Setup for short, is located, together with the setup parameters, in a FLASH block on the motherboard.

You change the setup parameters of the device in the BIOS Setup. Examples: System time, hard disks or boot order.

Changing the device configuration

Your device configuration is preset for operating with the included software. You should only change the default setup parameters if you have made technical changes to your device, or if a fault occurs when the device is switched on.

NOTICE

Malfunctions can occur with running software CPU

If a BIOS update of the PC is performed while SIMATIC software controller, a SIMATIC WinAC for example, is running, the software CPU can malfunction, resulting in communication interruptions or failures, for example. Other actions that put a heavy load on the PC hardware, for example, running hardware tests such as benchmarks, can result in malfunctions of the software CPU.

Do not run a BIOS update or other actions that would put a heavy load on the hardware during operation of a software CPU.

Switch the software CPU to "STOP" before you run a BIOS update or perform other critical actions.

Note

Documentation

BIOS Setup is described for all devices and device configurations. Some BIOS submenus or Setup parameters may not be included, depending on your order. The interface of your BIOS Setup can deviate from the figures in this document.

You can find a detailed description of the BIOS on the Support website under Entry ID 92189185 (<http://support.automation.siemens.com/WW/view/en/92189185>).

8.6.2 Opening the BIOS selection menu

Procedure

1. Reset the device (warm or cold restart).
Depending on the device version, the default settings can differ from the figures shown.
The following message appears briefly on the display at the end of the self-test:

Press ESC for boot options

2. Press <ESC> to open the BIOS selection menu:



The following keys are available in the BIOS selection menu:

Buttons	Function
Continue	Exit selection menu, continue start sequence
Boot Manager	Specify the boot media from which to boot: <ul style="list-style-type: none"> • Hard disk drive • CD-ROM drive • USB drive
Device Management	Start device manager for UEFI boot media
Boot From File	Boot Maintenance Manager: <ul style="list-style-type: none"> • Boot Options: Set boot order • Driver Options: Configure drivers • Console Options: Configure connected input device • Boot from File: Start from an ".EFI" file • Reset System: Restore factory settings
Secure Boot Option ¹	Configuration settings to start the device in Secure Boot mode. The only software modules loaded are those that are known to be safe for the BIOS or the operating system.
SCU	Start BIOS Setup via Setup Configuration Utility
BIOS Update	Update BIOS from USB memory stick
MEBx	Start Intel Management Engine BIOS Extension from Active Management Technology Support (AMT)

¹ Available as of Windows 8 or later

8.6.3 Configuration

The individual setup parameters are distributed between different menus and submenus. The menus always have the same layout.

Menu layout

The following figure is an example for the main menu. Device-specific information is shown as blurred.

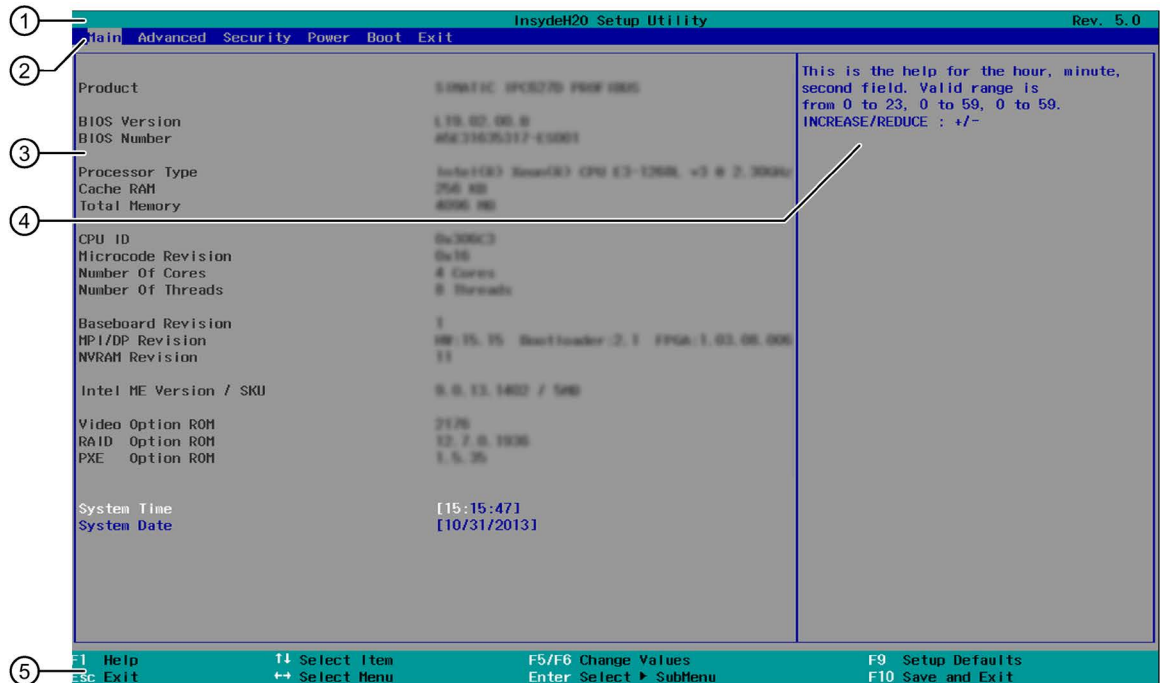

- ① Header
- ② Menu bar
- ③ Settings, submenus and device-specific information
- ④ Help area
- ⑤ Key assignment

A menu is divided into four areas:

- In the menu bar ② on top, you select from the different menus "Main", "Advanced", etc.
- The center left area ③ includes information on your device and you can edit settings that are partly available in submenus.
- The center right area ④ displays short help texts for the currently selected setup parameters.
- The key assignment ⑤ at the bottom shows the function keys and control keys available in BIOS Setup.

You can toggle between the menus with the "←" left and "→" right cursor keys.

The following table shows the standard menus. Not all menus are included in each supplied device configuration.

Menu	Meaning
Main	Display system information, for example, BIOS version, processor and memory
Advanced	Configure hardware using different submenus
Security	Security functions, e.g., setting a password
Power	Specify CPU settings and switch-on functions.
Boot	Determine boot options, e.g., boot order
Exit	Save and exit (see Exit menu)

8.6.4 Exit menu

You always exit BIOS Setup in this menu.

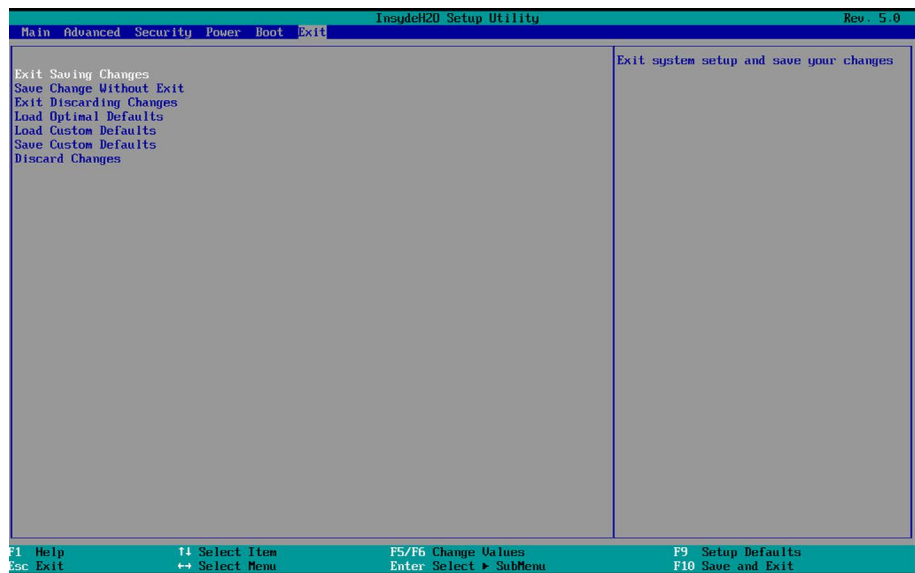

Exit Saving Changes	All changes are saved and the system is restarted with the new Setup parameters.
Save Change Without Exit	All changes are saved
Exit Discarding Changes	All changes are discarded and the system is restarted with the old Setup parameters.
Load Optimal Defaults	All setup parameters are reset to the safe default values. Notice: The existing Setup parameters are overwritten by this.
Load Custom Defaults	The profile must be loaded with the custom Setup parameters. Requirement: The parameters are saved prior to this with "Save Custom Defaults".
Save Custom Defaults	The currently configured Setup parameters are saved as a custom profile (see also "Load Custom Defaults").
Discard Changes	All changes are discarded.

See also

SIMATIC IPC after-sales information system (<http://www.siemens.com/asis>)

8.6.5 General BIOS Setup settings

If you have changed any default settings in Setup, you can enter them in the following table. You can then refer to these entries for any future hardware modifications.

Note

Print out the table below and keep the pages in a safe place once you made your entries.

The default setup settings vary depending on the ordered device configuration.

BIOS Setup settings

Main

System parameters	Default settings	Local settings
System Time	00:00:00	
System Date	MM/DD/YYYY	

Advanced

System parameters	Default settings	Local settings
HPET – HPET Support	Enabled	

Advanced > Boot Configuration

System parameters	Default settings	Local settings
Numlock	On	

Advanced > Peripheral Configuration

System parameters	Default settings	Local settings
Internal COM 1	Auto	
Base I/O Address ²	3F8	
Interrupt ²	IRQ4	
Internal COM 2 ¹	Auto	
Base I/O Address ^{1 2}	2F8	
Interrupt ^{1 2}	IRQ3	
PCI - MPI / DP	Enabled	
Profinet	Enabled	
CAN ¹	Auto	
Base I/O Address ^{1 3}	5400	
Interrupt ^{1 3}	IRQ5	
Azalia internal HDMI codec ⁴	Enabled	
Onboard Ethernet 1	Enabled	
Onboard Ethernet 2	Enabled	

¹ Depending on the ordered device configuration

² Only visible if the corresponding parameter "Internal COM#" is enabled.

³ Only visible if "CAN" is enabled.

⁴ Only available if an Azalia HD audio controller is installed.

Advanced > IDE Configuration

System parameters	Default settings	Local settings
SATA Port 0 Device Type	Hard Disk Drive	
SATA Port 1 Device Type	Hard Disk Drive	
SATA Port 2 HotPlug	Disabled	
SATA Port 2 Device Type	Hard Disk Drive	
HDC Configure As	AHCI	

Advanced > Video Configuration

System parameters	Default settings	Local settings
Primary Display	Auto	
IGD - Aperture Size	128 MB	
IGD - DVMT Size	MAX	
IGD - Boot Type	VBIOS Default	
IGD - Boot Type 2	Disabled	

Advanced > USB Configuration

System parameters	Default settings	Local settings
XHCI Pre-Boot Driver	Disabled	
XHCI	Auto	
The following 4 parameters are only visible if "XHCI" is enabled (Enabled).		
HS Port Switch 1	Enabled	
HS Port Switch 2	Enabled	
HS Port Switch 3	Enabled	
HS Port Switch 4	Enabled	
Per-Port Control	Disabled	
The following parameters are only visible if "Per-Port Control" is enabled (Enabled).		
USB Port0	Enabled	
USB Port1	Enabled	
USB Port2	Enabled	
USB Port3	Enabled	
USB Port: Front	Enabled	
USB Port: Internal	Enabled	

Advanced > Chipset Configuration

System parameters	Default settings	Local settings
VT-d	Enabled	
Interrupt Remapping ¹	Disabled	
Pass-Through DMA ¹	Disabled	

¹ Only visible if VT-d is enabled.

Advanced > Active Management Technology Support

System parameters	Default settings	Local settings
Intel AMT Support	Enabled	
Intel AMT Setup Prompt	Enabled	
MEBx Selection Screen	Disabled	
Un-Configure ME	Disabled	
Intel AMT Password Write	Enabled	
AMT CIRA Request Trig	Disabled	
USB Configure	Enabled	
Intel AMT SPI Protected	Disabled	

Advanced > PCIe Slot Configuration

System parameters	Default settings	Local settings
Slot0 - GenX	Gen1	
Slot1 - GenX	Gen1	
Slot2 - GenX	Gen1	

Security

System parameters	Default settings	Local settings
Power-on Password	Disabled	
User Access Level	Full	
TPM Operation ¹	No Operation	
TPM Force Clear ¹	Disabled	

¹ Visible depending on the ordered device configuration

Power

System parameters	Default settings	Local settings
Wake on LAN	Enabled	
PROFINET port is On ¹	Enabled	
PROFINET Wake Capability ^{1 2}	Disabled	
USB Ports 0/1 Wake Capability	Disabled	
USB Ports 2/3 Wake Capability	Disabled	
USB Port Internal Wake Capability	Disabled	
USB Port Front Wake Capability	Disabled	
USB Ports Touch Wake Capability	Disabled	

¹ Visible depending on the ordered device configuration

² Only visible if the parameter "PROFINET port is On" is enabled.

Power > Advanced CPU Control

System parameters	Default settings	Local settings
AES	Enabled	
P-States (IST)	Enabled	
HT Support	Auto	
Use XD Capability	Enabled	
VT Support	Enabled	
C-States	Enabled	
Turbo Mode	Enabled	
Turbo Mode Level	High Performance	

Boot

System parameters	Default settings	Local settings
Boot Type	Dual Boot Type	
Quick Boot	Enabled	
Quiet Boot	Enabled	
PXE Boot to LAN	Disabled	
Add Boot Options	Auto	
USB Boot	Enabled	
EFI Device First	Enabled	
Boot Delay Time	3 Seconds	
Normal Boot Menu	Normal	

Boot > Legacy

System parameters	Default settings	Local settings
Normal Boot Menu	Normal	

Exit

System parameters	Default settings	Local settings
Profile:		

8.6.6 BIOS update

Check regularly if updates are available for download to your device.

Additional information can be found on the Internet at the following address: SIMATIC IPC after-sales information system (<http://www.siemens.com/asis>).

Noting down and restoring BIOS Setup settings

NOTICE
<p>Irretrievable loss of data</p> <p>All BIOS Setup settings are deleted after the BIOS update. This can put the system in an undefined state. This may damage the device and the plant.</p> <ol style="list-style-type: none"> 1. Print out the table in the next section "General BIOS Setup settings". 2. Enter your specific BIOS Setup setting in this table before you run a BIOS update. 3. Start BIOS Setup after the BIOS update. 4. Load the BIOS Setup default settings with <F9> "Setup Defaults". Or use the BIOS Setup command "Load Optimal Defaults" in the "Exit" menu. 5. Make your own Setup settings based on the table you have printed out. 6. Save the BIOS Setup settings with <F10> "Save and Exit".

Performing a BIOS update

NOTICE
<p>Damage to the device</p> <p>If you switch off the device during the update, the BIOS will be incomplete and corrupt. This may result in malfunctions.</p> <p>Leave the device switched on during the update.</p>

If you have purchased a new BIOS update for your device, follow these steps to install the update:

1. Copy the update to a USB memory stick.
2. Reset the device (warm or cold restart).

The following message appears briefly on the display at the end of the self-test:

```
Press ESC for boot options
```

3. Press <ESC> to open the BIOS selection menu.
4. Click the "BIOS Update" button.
5. Follow the instructions on the screen.

Reboots

There may be several reboots after a BIOS update. These reboots are initiated by the Management Engine (ME). The reboots are required by the ME to adapt itself to the changes of the BIOS update.

8.6.7 Alarm, error and system messages

During startup (the boot process), the BIOS first performs a **Power On Self Test (POST)** and checks whether certain functional units of the PC are operating error-free. The boot sequence is immediately interrupted if critical errors occur.

BIOS initializes and tests further functional units if the POST does not return any errors. In this startup phase, the graphics controller is initialized and any error messages are output to the screen.

The error messages output by system BIOS are listed below. For information on error messages output by the operating system or application programs, refer to the corresponding manuals.

On-screen error messages

On-screen error message	Meaning / tip
Operating system not found	Possible causes: <ul style="list-style-type: none"> • No operating system installed • Incorrect active boot partition • Wrong boot drive settings in SETUP
Keyboard controller error	Controller error. Contact your technical support team.
SMART failure detected on HDD	Hard disk reports pending failure through S.M.A.R.T.
CMOS battery failed	CMOS battery is not connected.
CMOS battery weak	CMOS battery is weak
Real-time clock has lost power	The CMOS clock was operated without battery or with a battery that was too weak, during battery change, for example. Check the CMOS clock.
Keyboard error	No keyboard inserted.
PLD configuration failed	Programming of the PLC on the motherboard has failed.

8.7 Active Management Technology (AMT)

8.7.1 Introduction

Intel® Active Management Technology (Intel® AMT) is an Intel technology for the remote maintenance of SIMATIC Industrial PCs (IPCs) with AMT technology using a management PC. It is not necessary to install an operating system on the SIMATIC IPC with Intel® AM. Intel® AMT provides numerous functions, e.g.:

- **Keyboard Video Mouse (KVM) Redirection**

KVM connections are always possible using the KVM server that is integrated in the firmware. KVM enables access to IPCs with a corrupted or no operating system as the KVM server is integrated in the AMT hardware. KVM enables you to reboot a remote computer and make changes to its BIOS settings.

- **Remote power management**

SIMATIC IPC with Intel ® AMT can be switched on and off or restarted using another PC.

- **IDE redirection**

An image on the management PC can be integrated and used on the SIMATIC IPC with Intel® AMT both as a CD/DVD drive and as a floppy drive. If the image is bootable, you can also boot the SIMATIC IPC with Intel® AMT from it.

The following figure shows remote maintenance of SIMATIC IPCs with Intel® AMT, e.g. for troubleshooting a corrupt operating system or incorrect BIOS settings:

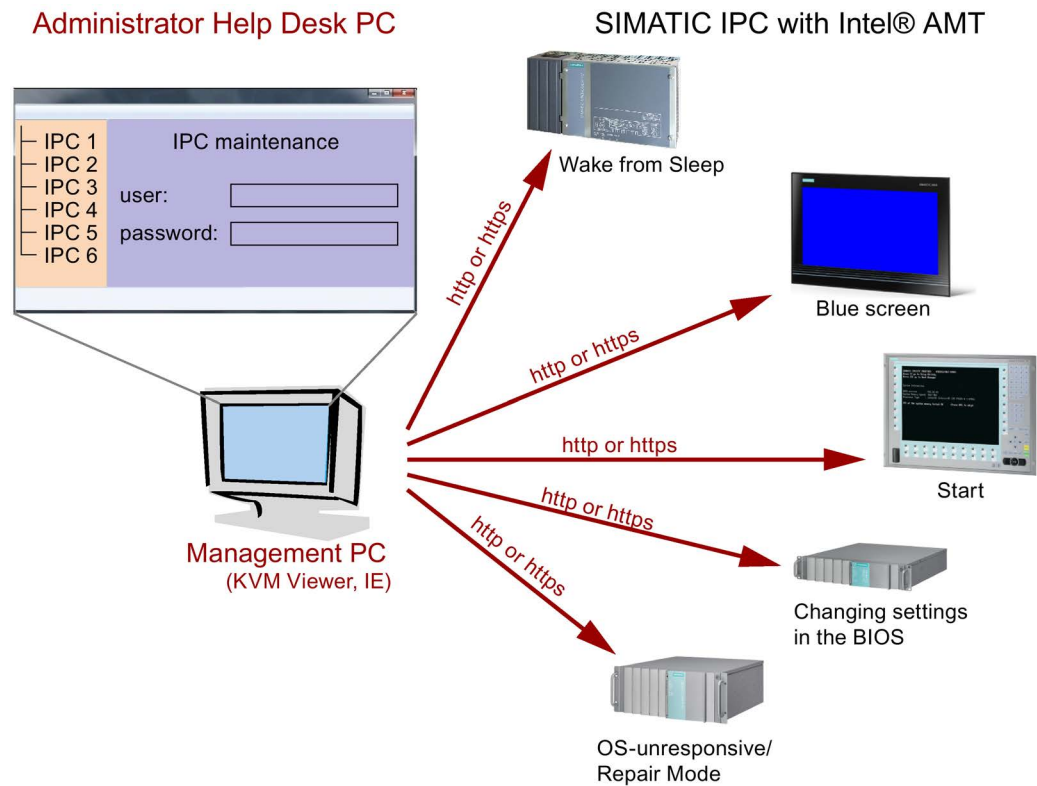

8.7.2 Overview of AMT

This section describes the required measures and settings on the local IPC so that the IPC can be controlled and maintained remotely from a management station known below as the help desk PC.

The local IPC is known below as the "AMT PC".

The sections contain the following information:

- AMT settings in the MEBx and in the BIOS setup
- Basic configuration of AMT
- Further useful notes

8.7.3 Enabling Intel® AMT / basic configuration

For security reasons, Intel® AMT is not enabled on new devices. The Management Engine (ME) is always active.

Procedure

For IPCxxxD and Field PG M4 devices:

1. If necessary, first reset Intel® AMT to the default status.
2. To open the BIOS selection menu, press the <ESC> key while the device is booting.
3. Open the BIOS Setup using the "Setup Configuration Utility (SCU)".
4. Select the "Active Management Technology Support" command in the Advanced menu.
For IPC547D and IPC547E devices only: Select "AMT Configuration".
5. Activate the option "Intel AMT Support".
6. For IPC547D and PC547E devices only: Select the "Normal" setting for "MEBx Mode".
7. Exit the BIOS Setup with <F10> key (Save and Exit).
For IPC547D and IPC547E devices only: Exit the BIOS Setup with <F4> key.

For IPCxxxC devices:

1. To open the BIOS selection menu, press the <F2> key while the device is booting.
2. Open the BIOS Setup using the "Setup Configuration Utility (SCU)".
3. Select the "Active Management Technology Support" command in the Advanced menu.
4. Activate the option "Intel AMT Support".
5. Activate the option "Intel AMT Setup Prompt".
6. Exit the BIOS Setup with <F10> key (Save and Exit).

Settings in the MEBx

1. Use the arrow keys to select "MEBx" and confirm with the <Enter> key.
2. Select "MEBx Login".
3. Enter the default password "admin".

Change the password. The new password must comprise:

- At least eight characters
- An upper case letter
- A lower case letter
- A number
- A special character (! @ # \$ % ^ & *)
- The underscore "_" and space characters are valid in the string but do not increase the complexity of the password.

Note

If the password is no longer available, you must reset the Intel® AMT to the default settings, see [Resetting the Intel® AMT to the default settings and disabling AMT](#) (Page 185).

Backup the password to protect it against loss.

4. Switch to the "Intel (R) AMT Configuration" submenu and enable "Manageability Feature Selection".
5. Switch to the "Intel(R) ME General Settings" submenu and enable access via the network with "Activate Network Access".
6. Confirm the dialogs that appear with "Y".

Drivers are automatically installed once as required in the subsequent restart.

8.7.4 Resetting the Intel® AMT to the default settings and disabling AMT

If Intel® AMT has already been configured, it is advisable to reset Intel® AMT to the default settings. One effect of resetting to the default settings is that Intel® AMT is disabled.

You can skip this point if you have a new IPC in the factory state.

Procedure

Proceed as follows to reset the Intel® AMT to the default values:

1. Press "F2" in the boot sequence to open the BIOS.
2. Select the "Active Management Technology Support" command in the Advanced menu, for an IPC547D/IPC547E select "AMT Configuration".
3. Set "Un-Configure ME" or "Un-Configure AMT/ME" to Enabled.
4. Exit the BIOS with "F10" (Save and Exit).
You can exit the IPC547D/547E with "F4".

The following prompt will appear after an automatic restart:

```
Found unconfigure of Intel(R) ME
Continue with unconfiguration (Y/N)
```

5. Confirm this prompt with "Y" to discard all settings in the Management Engine (ME).
6. For IPC627C/827C/677C/647C/847C/427D/477D/Field PG M4, you now need to set the "Un-Configure ME" menu command in the BIOS back to Disabled.

8.7.5 Determining the network address

To connect the AMT PC with the AMT server, the network address that uniquely localizes the AMT server on the AMT PC must be entered.

If DHCP is set for the automatic assignment of the network address in "Network Setup" in the MEBx of the AMT PC, the network address is not fixed.

Procedure

If the AMT server uses the same network address as the operating system of the AMT PC (most common situation):

1. You can obtain the address of the AMT server in the command line in Windows using "ipconfig" and in UNIX using "ifconfig".

If the AMT server and operating system do not use the same network address, ask your network administrator for the address you have been assigned.

8.7.6 Forcing user consent

When establishing a connection to the AMT PC, the KVM viewer may prompt the user to enter a six-figure code. This code is displayed on the screen of the AMT PC. The user of the AMT PC must inform the user of the KVM viewer of this code.

This code query needs to be set up on the KVM viewer.

Procedure

1. Select "Intel(R) AMT Configuration > User Consent" in the MEBx.
2. Select the value "KVM" for "User Consent".

To allow a user with administrator privileges to avoid this code query, follow these steps:

1. Select "Intel(R) AMT Configuration > User Consent" in the MEBx.
2. Enable "Opt-in configurable from remote IT".

8.8 Functional scope in Windows

8.8.1 Windows Embedded Standard 7

The overview shows the most important device functions under Windows Embedded Standard 7:

Function	HDD / SSD version	Memory card version
.Net Framework	Available, V3.5	Available, V3.5
Accessories	Available	Available
Aero background	Available	Available
Backup and Restore	Available	Available
Bluetooth	Available	Available
Dialog box filter	Available	Available
DirectX and Windows Device Experience	Available, V11	Available, V11
Domain services	Available	Available
Driver database	Available	Not available
Driver frameworks	Available	Available
Encrypted File System (EFS)	Available	Available
Enhanced Write Filter	Available	Available
Fax and Scan	Available	Available
File Based Write Filter (FBWF)	Available	Available
Fonts	134	48
Help and Support Engine	Available	Available
Hibernate Once Resume Many (HORM)	Available	Available
Image Mastering API V2	Available	Available
IME Base Components	Available	Available
Internet Explorer	Available, IE 8	Available, IE 8
Internet Information Server (IIS)	Available, V7.0	Available, V7.0
Language (Standard)	English ¹	English ¹
Mobility Center	Available	Available
Network and Sharing Center	Available	Available
Network Diagnostics	Available	Available
Pagefile	Available	Available
Printing Utilities and Management	Available	Available
Registry Filter	Available	Available
Remote Assistance	Available	Available
Remote Client	Available	Available
Remote Desktop	Available	Available
SIMATIC IPC DiagBase	Available, V1.4	Available, V1.4
Speech	Available	Not available
System Management Administrative Tools	Available	Available

Function	HDD / SSD version	Memory card version
Telnet Server	Available	Available
User Account Control	Available	Available
Windows Explorer Shell	Available	Available
Windows Firewall	Available	Available
Windows Installer	Available	Available
Windows Media Player	Available, V12	Available, V12
Windows PowerShell 2.0	Available	Available
Windows Search and Natural Language 6	Available	Available
Windows Security Center	Available	Available
Windows Update	Available	Available
Wireless Networking	Available	Available

¹ Note the licensing agreements for Windows Embedded Standard 7.

Additional information on language selection is available in the section "Setting up the language selection by means of the Multilanguage User Interface (MUI) (Page 124)".

Technical support

A.1 Service and support

You can find additional information and support for the products described on the Internet at the following addresses:

- Technical support (http://www.siemens.de/automation/csi_en_WW)
- Support request form (<http://www.siemens.com/automation/support-request>)
- After Sales Information System SIMATIC IPC/PG (<http://www.siemens.com/asis>)
- SIMATIC Documentation Collection (<http://www.siemens.com/simatic-tech-doku-portal>)
- Your local representative
(<http://www.automation.siemens.com/mcms/aspa-db/en/Pages/default.aspx>)
- Training center (<http://sitrain.automation.siemens.com/sitrainworld/?AppLang=en>)
- Industry Mall (<https://mall.industry.siemens.com>)

When contacting your local representative or Technical Support, please have the following information at hand:

- MLFB of the device
- BIOS version for industrial PC or image version of the device
- Other installed hardware
- Other installed software

Tools & downloads

Please check regularly if updates and hotfixes are available for download to your device. The download area is available on the Internet at the following link:

After Sales Information System SIMATIC IPC/PG (<http://www.siemens.com/asis>)

A.2 Problem solving

This section provides you with tips on how to locate and/or troubleshoot problems which occur.

Problem	Possible cause	Possible remedy
The device is not operational	No power supply	<ul style="list-style-type: none"> • Check the power supply, the power cord and the power plug. • Check if the On/Off switch is in the correct position.
	Device is being operated outside the specified ambient conditions	<ul style="list-style-type: none"> • Check the ambient conditions. • After transport in cold weather, wait approximately 12 hours before switching on the device.
The monitor remains dark	The brightness button has been set to dark	Increase brightness using the brightness button. For detailed information, refer to the monitor operating instructions.
	Power cord is not connected	<ul style="list-style-type: none"> • Check whether the power cord has been properly connected to the monitor and to the system unit or to the grounded shockproof outlet. • If the monitor screen still remains dark after you have performed these checks and measures, contact your technical support team.
The mouse pointer does not appear on the screen	The mouse driver is not loaded	Check whether the mouse driver is properly installed and available when you start the user program. Detailed information about the mouse driver is available in the corresponding documentation.
	Mouse not connected.	<ul style="list-style-type: none"> • Check whether the mouse cord is properly connected to the system unit. • If you use an adapter or expansion for the mouse cable, also check these connectors. • If the mouse pointer still does not appear on the screen after you have performed these checks and actions, contact your technical support team.
Wrong time and/or date on the PC		<ol style="list-style-type: none"> 1. Press <F2> during the booting process to open the BIOS Setup. 2. Set the time and date in the setup menu.
Although the BIOS setting is OK, the time and data are still wrong.	The backup battery is dead.	Replace the backup battery.
USB device not responding.	The USB ports are disabled in BIOS.	Use a different USB port or enable the port.
	The operating system does not support the USB ports.	<ul style="list-style-type: none"> • Turn on USB Legacy Support for mouse and keyboard. • For other devices, you need the USB device drivers for the required operating system.
"chkdsk" is not functioning	EFW (Enhanced Write Filter) has been activated. The "chkdsk" command is not supported if the EFW has been activated.	Deactivate the EFW or use an alternative method to "chkdsk".

A.3 Notes on the use of third-party modules

Problem	Possible cause	Possible remedy
The PC crashes during startup.	<ul style="list-style-type: none"> • I/O addresses are assigned twice. • Hardware interrupts and/or DMA channels are assigned twice • Signal frequencies or signal levels are not adhered to • Different connector pin assignments 	<p>Check your computer configuration:</p> <ul style="list-style-type: none"> • If the computer configuration corresponds with factory state, please contact your technical support team. • If the computer configuration has changed, restore the original factory settings. Remove all third-party expansion cards, then restart the PC. If the error no longer occurs, the third-party expansion card was the cause of the fault. Replace this expansion card with a Siemens card or contact the card supplier.
	<p>PCIe Gen1 expansion card does not behave according to specification.</p>	<p>If the PC still crashes, contact your technical support team.</p> <ol style="list-style-type: none"> 1. Remove the expansion card. 2. Set the respective setup parameter "PCIe Speed" permanently to "Gen1" in the "Advanced > PCI Express Configuration" menu, submenu "PCI Express Root Port #" of the BIOS Setup. 3. Set the respective setup parameter "PEG# - Gen X" permanently to "Gen1" in the "Advanced > Video Configuration" menu, submenu "Pci Express Graphic" of the BIOS Setup. 4. Install the expansion card again.

List of abbreviations

Abbreviation	Term	Meaning
AC	Alternating current	Alternating current
ACPI	Advanced Configuration and Power Interface	
PLC	Programmable controller	
AGP	Accelerated Graphics Port	High speed bus system
AHCI	Advanced Host Controller Interface	Standardized controller interface for SATA devices. This is supported in Microsoft Windows XP as of SP1 and IAA driver.
APIC	Advanced Programmable Interrupt Controller	Extended programmable interrupt controller
APM	Advanced Power Management	Tool for monitoring and reducing power consumption of the PC
AS	Automation system	
ASIS	After Sales Information System	
AT	Advanced Technology	
ATA	Advanced Technology Attachment	
ATX	AT-Bus-Extended	
AWG	American Wire Gauge	US standard for the cable diameter
BIOS	Basic Input Output System	Basic Input Output System
CAN	Controller Area Network	
CD-ROM	Compact Disc – Read Only Memory	Removable storage medium for large data volumes
CD-RW	Compact Disc – Rewritable	Rewritable CD
CE	Communauté Européenne (CE symbol)	The product is in conformance with all applicable EC directives
CFast	CF + AST	The acronym CFast is the combination of CF (Compact-Flash) and AST (ATA Serial Transport).
CGA	Color Graphics Adapter	Standard monitor interface
CLK	Clock pulse	Clock signal for controllers
CMOS	Complementary Metal Oxide Semiconductors	Complementary metal oxide semiconductors
COA	Certificate of authentication	Microsoft Windows Product Key
CoL	Certificate of License	License authorization
COM	Communications Port	Term for the serial interface
CP	Communication Processor	Communication computer
CPU	Central Processing Unit	CPU
CRT	Cathode Ray Tube	
CSA	Canadian Standards Association	Canadian organization for tests and certifications according to own or binational standards (with UL / USA) standards
CTS	Clear To Send	Clear to send

Abbreviation	Term	Meaning
DRAM	Dynamic Random Access Memory	
DC	Direct Current	DC current
DCD	Data Carrier Detect	Data carrier signal detection
DMA	Direct Memory Access	Direct memory access
DOS	Disk Operating System	Operating system without GUI
DPP	DisplayPort	New powerful digital monitor port
DQS	Deutsche Gesellschaft zur Zertifizierung von Qualitätsmanagement mBH	
DDRAM	Double Data Random Access Memory	Memory chip with high-speed interface
DSR	Data Set Ready	Ready for operation
DTR	Data Terminal Ready	Data terminal is ready
DVD	Digital Versatile Disk	Digital versatile disk
DVI	Digital Visual Interface	Digital display interface
DVI-I	Digital Visual Interface	Digital display interface with digital and VGA signals
ECC	Error checking and correction	Error correction code
ECP	Extended capability port	Extended parallel port
EFI	Extensible Firmware Interface	
EGA	Enhanced Graphics Adapter	PC to monitor interface
ESD	Electrostatic-sensitive components	
DM	Electronic Manual	
EIDE	Enhanced Integrated Drive Electronics	An enhancement of the IDE standard
EISA	Extended Industry Standard Architecture	Extended ISA standard
EMM	Expanded Memory Manager	Manages memory expansions
EM64T	Extended Memory 64 technology	
EN	European standard	
EPROM / EEPROM	Erasable Programmable Read-Only Memory / Electrically Erasable Programmable Read-Only Memory	Plug-in submodules with EPROM/EEPROM chips
EPP	Enhanced Parallel Port	Bi-directional Centronics interface
ESC	Escape character	Control character
EWf	Enhanced Write Filter	
FAQ	Frequently Asked Questions	FAQs
FAT 32	File Allocation Table 32-bit	32-bit file allocation table
FBWF	File Based Write Filter	
FD	Floppy disk	Disk drive, 3.5"
FSB	Front Side Bus	
GND	Ground	Chassis ground
HD	Hard disk	Hard disk
HDA	High Definition Audio	
HDD	Hard Disk Drive	Hard disk drive
HU	Height unit	
HMI	Human Machine Interface	User interface
HORM	Hibernate Once - Resume Many	

Abbreviation	Term	Meaning
HT	Hyper-Threading	
HTML	Hyper Text Markup Language	Script language for creating Internet pages.
HTTP	Hypertext Transfer Protocol	Protocol for data transfer on the Internet
Hardware	Hardware	
IAMT	Intel Active Management Technology	Technology that permits the diagnostics, management and remote control of PCs
I/O	Input/Output	Data input/output on computers
IAA	Intel Application Accelerator	
IDE	Integrated Device Electronics	
IEC	International Electrical Commission	
IGD	Integrated Graphics Device	
IP	Ingress Protection	Degree of protection
IR	Infrared	Infrared
IRDA	Infrared Data Association	Standard for data transfer via IR module
IRQ	Interrupt Request	Interrupt request
ISA	Industry Standard Architecture	Bus for expansion modules
ITE	Information Technology Equipment	
L2C	Level 2 cache	
LAN	Local Area Network	Computer network that is limited to a local area.
LCD	Liquid Crystal Display	Liquid crystal display
LED	Light Emitting Diode	Light emitting diode
LPT	Line Printer	Printer port
LVDS	Low Voltage Differential Signaling	
LW	Drive	
MAC	Media access control	Media access control
MC	Memory Card	Memory card in credit card format
MLFB	Machine-readable product designation	
MMC	Micro Memory Card	Memory card of the format 32 mm x 24.5 mm
MPI	Multipoint-capable interface for programming devices	
MRAM	Magnetoresistive Random Access Memory	Non-volatile data memory. Data memory is retained without external power supply.
MS-DOS	Microsoft Disc Operating System	
MTBF	Mean Time Between Failures	
MUI	Multilanguage User Interface	Multilanguage operating system with Windows with language toggling; 5 languages: German, English, French, Spanish and Italian
NA	Not Applicable	
NAMUR	Normenarbeitsgemeinschaft for Mess- und Regelungstechnik in der chemischen Industrie (standardization body for instrumentation and control technology in the chemicals industry)	
NC	Not Connected	Not connected

Abbreviation	Term	Meaning
NCQ	Native Command Queuing	Automatic re-sorting of the file and disk access, for increased performance
NEMA	National Electrical Manufacturers Association	Syndicate of manufacturers of electrical components in the USA
NMI	Non Maskable Interrupt	Interrupt the processor can not reject
NTFS	New Techniques File System	Secure file system for Windows versions (2000, XP, 7)
ODD	Optical Disk Drive	
OPC	OLE for Process Control	Standardized interface for industrial processes
PATA	Parallel ATA	
PC	Personal computer	
PCI	Peripheral Component Interconnect	High-speed expansion bus
PCIe	Peripheral Component Interconnect express	High-speed serial, differential full-duplex PtP interface with high data rate.
PCMCIA	Personal Computer Memory Card International Association	
PE	Protective Earth	Protective conductor
PEG	PCI Express Graphics	
PG	Programming device	
PIC	Programmable Interrupt Controller	Programmable interrupt controller
PIC-E	Peripheral Component Interconnect Express	
POST	Power On Self Test	
PXE	Preboot Execution Environment	Software for running new PCs without hard disk data via the network
RAID	Redundant Array of Independent Disks	Redundant hard disk array
RAL	Restricted Access Location	Installation of device in operating facilities with restricted access - for example, a locked switchgear cabinet
RAM	Random Access Memory	
RI	Ring Input	Incoming call
ROM	Read-Only Memory	
RS 485	Reconciliation Sublayer 485	Bi-directional bus system designed for up to 32 nodes
RTC	Real Time Clock	Real-time clock
RTS	Reliable Transfer Service	Request to send
RxD	Receive Data	Data transfer signal
SATA	Serial Advanced Technology Attachment	
SCSI	Small Computer System Interface	
SDRAM	Synchronous DRAM	
SELV	Safety Extra Low Voltage	Safety extra low voltage
SLC	Second Level Cache	
SMART	Self Monitoring Analysis and Reporting Technology	Hard disk error diagnostics program
SMS	Short Message Service	Short message via telecommunication network
SNMP	Simple Network Management Protocol	Network protocol
SO-DIMM	Small Outline Dual Inline Memory Module	
SOM	SafeCard on Motherboard (SOM)	

Abbreviation	Term	Meaning
SPP	Standard Parallel Port	Synonym for parallel port
SRAM	Static Random Access Memory	Static RAM
SSD	Solid State Drive	
SVGA	Super Video Graphics Array	Enhanced VGA standard with at least 256 colors
SVP	Serial number of the device	
SW	Software	
TCO	Total Cost of Ownership	
TFT	Thin-Film-Transistor	Type of LCD flat-screen
TPM	Trusted Platform Module	Chip with security functions
TTY	Tele Type	Asynchronous data transfer
TxD	Transmit Data	Data transfer signal
TXT	Trusted Execution Technology	Hardware implementation
TWD	Watchdog Time	Watchdog monitoring time
UEFI	Unified Extensible Firmware Interface	
UL	Underwriters Laboratories Inc.	US organization for tests and certifications according to own or binational standards (with CSA / Canada) standards.
UMA	Unified Memory Architecture	Video memory
URL	Uniform Resource Locator	Designation of the full address of an Internet page
USB	Universal Serial Bus	
UXGA	Ultra Extended Graphics Array	Graphic standard, maximum resolution 1600x1200 pixels.
V.24		ITU-T standardized recommendation for data transfer via serial ports
VCC		Positive supply voltage of integrated circuits
VDE	Verein deutscher Elektrotechniker (Union of German Electrical Engineers)	
VGA	Video Graphics Array	Video adapter which meets industrial standard
VRM	Voltage Regulator Module	
VT	Virtualization Technology	Intel technology with which a virtually closed environment can be made available.
VT-D	Virtualization Technology for Directed I/O	Enables the direct assignment of a device (e.g. network adapter) to a virtual device.
W2k	Windows 2000	
WAN	Wide Area Network	
WAV	Wave Length Encoding	Loss-free file format for audio data
WD	Watchdog	Program monitoring with error detection and alarming.
WLAN	Wireless LAN	LWireless local area network
WoL	Wake on Local Area Network	
WWW	World Wide Web	
XD	Execute Disable Capability	Hardware implementation
XGA	Extended Graphics Array	Graphic standard, maximum resolution 1024x768 pixels.

Glossary

AHCI mode

AHCI is a standardized method to address the SATA controller. AHCI describes a structure in the RAM, which contains a general area for control and status, as well as a command list.

APIC mode

Advanced peripheral interrupt controller. 24 interrupt lines are available.

Automation system

A programmable controller (PLC) of the SIMATIC S7 system consist of a central controller, one or several CPUs, and various I/O modules.

Backup

Duplicate of a program, data medium or database, used either for archiving purposes or for the protection of vital and non-replaceable data against loss when the working copy is corrupted. Certain applications automatically generate backup copies of data files, and manage both the current and the previous versions on the hard disk.

Baud

Physical unit for the step speed in signal transmission. Defines the number of transferred signal states per second. With only two states, one baud is equivalent to a transmission rate of 1 bps.

Boot disk

A boot disk is a disk with a "Boot" sector. This can be used to load the operating system from the disk.

Cache

High-speed access buffer for interim storage (buffering) of requested data.

CE marking

Communauté Européene The CE mark confirms compliance of the product with corresponding EC Directives, for example, with the EMC Directive.

CFast card

CFast is a digital storage medium in card form without moving parts. A CFast card uses the SATA protocol and its connectors are not compatible with a classic CompactFlash card.

Chipset

Located on the motherboard, connects the processor with the PCI or PCIe bus and the external interfaces.

Cold restart

A start sequence, starting when the computer is switched on. The system usually performs some basic hardware checks within the cold start sequence, and then loads the operating system from the hard disk to work memory -> boot

COM interface

The COM interface is a serial V.24 interface. The interface is suitable for asynchronous data transfer.

Configuration files

These are files containing data which define the configuration after restart. Examples of such files are CONFIG.SYS, AUTOEXEC.BAT and the registry files .

Configuration software

The configuration software updates the device configuration when new modules are installed . This is done either by copying the configuration files supplied with the module or by manual configuration using the configuration utility.

Controller

Integrated hardware and software controllers that control the functions of certain internal or peripheral devices (for example, the keyboard controller).

Device configuration

The configuration of a PC or programming device contains information on hardware and device options, such as memory configuration, drive types, monitor, network address, etc. The data are stored in a configuration file and enable the operating system to load the correct device drivers and configure the correct device parameters. . If changes are made to the hardware configuration, the user can change entries in the configuration file using the SETUP program. .

Drivers

Program parts of the operating system. They adapt user program data to the specific formats required by I/O devices such as hard disk, printers, and monitors.

EMC directive

Directive concerning **E**lectromagnetic **C**ompatib**l**ity. Compliance is confirmed by the CE symbol and the EC certificate of conformity.

Energy management

The energy management functions of a modern PC allow individual control over the current consumption of vital computer components (e.g. of the monitor, hard disk and CPU), by restricting their activity based on the current system or component load. Energy management is of particular importance for mobile PCs.

Energy options

The energy options can be used to reduce energy consumption of the computer, while keeping it ready for immediate use. This can be configured in Windows by selecting Settings > Control Panel > Energy options.

Enhanced Write Filter

Configurable write filter that allows you to, for example, boot Windows Embedded Standard from write-protected media (e.g., CD-ROM), set write protection for individual partitions, and adapt the file system performance to user requirements (when using memory cards, for example).

ESD Guideline

Guideline for using electrostatic sensitive components.

Ethernet

Local network (bus structure) for text and data communication with a transfer rate of 10/100/1000 Mbps.

Execute Disable Capability

Hardware implementation that prevents mutual memory accesses by programs and applications. It is only effective when all relevant system components, such as processors, operating systems and applications are supported.

Extensible Firmware Interface

Refers to the central interface between the firmware, the individual components of a computer and the operating system. EFI is located logically beneath the operating system and represents the successor to PC BIOS, focusing on 64-bit systems.

File Based Write Filter

Configurable write filter to protect individual files from write access.

Formatting

Basic partitioning of memory space on a magnetic data medium into tracks and segments. Formatting deletes all data on a data medium. All data media must be formatted prior to their first use.

HORM

Hibernate once, resume many is a method for fast booting from a single Hibernate file that only needs to be created once. HORM ensures restoration of a uniform, saved system state when booting. This minimizes write access, for example to a CompactFlash medium, when you start up and shut down Windows Embedded Standard 7.

Hub

A term in network technology. In a network, a device joining communication lines at a central location, providing a common connection to all devices on the network.

Hyper Threading

HT technology (multi-threading) enables the parallel computing of processes. HT is only effective when all relevant system components, such as processors, operating systems and applications are supported.

IGD

Integrated Graphics Device. Graphics interface integrated in the chipset.

Image

This refers to the image, for example, of hard disk partitions saved to a file in order to restore them when necessary.

Intel Active Management Technology

This technology permits the diagnostics, management and remote control of PCs. It is only effective when all relevant system components, such as processors, operating systems and applications are supported.

Intel VT

The Intel Virtualization Technology (IVT) is the implementation of a secure closed environment for applications. Special (visualization) software on a VT-capable processor is required for its use.

Interface

- Physical interconnection (cable) of hardware elements such as PLCs, PCs, programming devices, printers or monitors.
- Interface for interactive software applications.

LAN

Local Area Network: LAN is a local network that consists of a group of computers and other devices that are distributed across a relatively restricted range and are linked with communication cables. The devices connected to a LAN are called nodes. The purpose of networks is the mutual use of files, printers or other resources.

Legacy Boot Device

Conventional drives can be used as USB devices.

License key

The license key represents the electronic license stamp of a license. Siemens provides the license keys for protected software.

License key disk

The license key disk contains the authorizations or license keys required to enable protected SIMATIC software.

Low-voltage directive

EC Product Safety Directive relating to the safety of products which are operated on low voltage (50 V AC to 1000 V AC, 70 V DC to 1500 V DC) and not specified in other directives. Compliance is confirmed by the CE symbol and the EC certificate of conformity.

Module

Modules are plug-in units for PLCs, programming devices or PCs. They are available as local modules, expansion modules, interfaces or mass storage (Mass storage module).

Motherboard

The motherboard is the core of the computer. Here, data are processed and stored, and interfaces and device I/Os are controlled and managed.

Operating system

Generic term which describes all functions for controlling and monitoring user program execution, distribution of system resources to the user programs and the operating mode in cooperation with the hardware (for example, Windows 7 Ultimate).

Pixel

The pixel represents the smallest element that can be reproduced on-screen or on a printer.

Plug&Play

Generally, a reference to the ability of a computer to automatically configure the system for communication with peripheral devices (for example monitors, modems or printers). The user can plug in a peripheral and "play" it at once without manually configuring the system. A Plug&Play PC requires both a BIOS that supports Plug&Play and a Plug&Play expansion card.

POST

Self-test performed by the BIOS after the computer is switched on. Performs a RAM test and a graphics controller test, for example. The system outputs audible signals (beep codes) if the BIOS detects any errors; the relevant message indicating cause of error is output on the screen.

Programmable controller

The programmable controllers of the SIMATIC S5 system consist of a central controller, one or several CPUs and various other modules (for example, I/O modules).

PXE server

A Preboot Execution Environment server is part of a network environment and can provide software to connected computers even before they boot. This can involve operating system installations or servicing tools, for example.

RAL

Restricted Access Location: Installation of the device in a production facility with restricted access, for example, a locked control cabinet.

Recovery CD

Contains the tools for configuring hard disks and the Windows operating system.

Reset

Hardware reset: Reset/restart of the PC using a button/switch.

Restart

Warm restart of a computer without switching the power off (Ctrl + Alt + Del)

Restore DVD

The Restore DVD is used to restore the system partition or the entire hard disk to factory state if the system has crashed. The bootable DVD contains all the necessary image files.

ROM

Read-Only Memory ROM is a read-only memory in which every memory location can be addressed individually. The programs or data are permanently stored and are not lost in the event of a power failure.

S.M.A.R.T

The Self-Monitoring, Analysis and Reporting Technology (SMART or S.M.A.R.T.) is an industry standard integrated in storage media. It makes for permanent monitoring of important parameters and early detection of imminent problems.

SATA

Serial ATA Interface for hard disk drives and optical drives with serial data transmission rates of up to 300 Mbps.

SETUP (BIOS Setup)

A program in which information about the device configuration (that is the configuration of the hardware on the PC/PG) is defined. The device configuration of the PC/PG is preset with defaults. Changes must therefore be entered in the SETUP if a memory expansion, new modules or a new drive are added to the hardware configuration.

SSD (Solid State Drive)

A Solid State Drive is a drive that can be installed like any other drive; it does not contain a rotating disk or other moving parts because only semiconductor memory chips of similar capacity will be used. This design makes SSDs more rugged, provides shorter access times, low energy consumption and rapid data transfer.

STEP 7

Programming software for the creation of user programs for SIMATIC S7 controllers.

Troubleshooting

Error cause, cause analysis, remedy

Trusted Execution Technology

Hardware implementation that allows secured execution of programs and applications. It is only effective when all relevant system components, such as processors, operating systems and applications are supported.

Wake on LAN

Wake on Local area network. This function allows the PC to be started via the LAN interface.

Warm restart

The restart of a computer after a program was aborted. The operating system is loaded and restarted again. The CTRL+ ALT+ DEL hotkey can be used to initiate a warm restart.

Index

A

- Abbreviations, 193, 197
- Accessory kit, 25
- ACK key, 84
- Acknowledge key, 84
- Adapting
 - Partitioning, 128
- Alphanumeric keys, 83
- ALT key, 84
- Antivirus software, 75
- Australia, 132
- Automatic Update, 75

B

- Backplane cover, 97, 98
 - Closing, 98
 - Opening, 97
- Backspace key, 84
- Backup battery, 88
- Backup memory, 147, 153
- Base adapter, 27
- Battery monitoring, 88
- BIOS Setup, 173
 - Exit menu, 176
 - Menu layout, 175
- Boot sequence, 182
- Bottom view, 23

C

- CAN
 - Base address register, 169
- Cancel key, 84
- CE marking, 131
- Certificates, 131
 - Certifications and approvals, 131
- CFast card
 - Interface, 159
 - Removing from external slot, 105
 - Removing from internal slot, 106
- chkdsk, 190
- Cleaning Agents, 112
- COA label, 37
- COM1 port, 159

- Components sensitive to electrostatic charge, 133
- Condensation, 36
- Connecting
 - Network, 67
 - PE conductor, 64
 - Peripherals, 55
 - Power supply, 66
 - Protective conductor, 56, 57
- connecting the PE conductor, 64
- Connecting the protective conductor, 57
- Control keys, 84
- Coupling with SIMATIC S7, 67
- CP 1616 onboard, 68
- Creating an image, 130
- CTRL key, 84
- Cursor key, 85
- Cursor keys, 85

D

- Data backup, 130
- Data exchange, 67
- Degree of protection, 40, 145, 152
 - Protection against ingress of solid foreign bodies, 151, 156
 - Protection against water, 151, 156
- Delete key, 84, 84
- Device
 - Mounting, 47
 - Opening, 95
 - Switching off, 74
- Device configuration, 177
- Device driver CP16xx.sys, 69
- DiagBase software, 86
- DiagMonitor
 - Temperature monitoring, 86
- DiagMonitor software, 86
- Diagnostics, 86, 86
 - DiagBase software, 86
 - DiagMonitor software, 86
 - Error Messages, 182
- Directive
 - ESD Directive, 133
- Display, 12, 33
- DisplayPort
 - Interface, 160
- Distributed, 67
- Documentation and Drivers CD/DVD, 121

Drives, 147, 153
DVD burner, 78
DVI-I port, 161

E

Earth connection, 81
EC Declaration of Conformity, 131
Elbow adapter, 26
Electromagnetic compatibility, 146, 153
Enable register
 Watchdog, 168
END key, 85
Enhanced Write Filter, 88
Enter key, 84
ENTER key, 84
ESC key, 84
ESD, 133
ESD Directive, 133
Ethernet, 67
Ethernet address, 36
Ethernet interface, 162
EWF (Enhanced Write Filter), 88
Exit menu, 176

F

Factory state, 122
FBWF (File Based Write Filter), 90
FCC, 131
Field devices, 67
File Based Write Filter, 90
Fire protection covering, 44
Fire protection enclosure, 44
Firewall, 75
Front view, 23
Function key
 Labeling, 41

H

HMI device
 Installing, 52
HOME key, 85

I

Industrial Ethernet, 67
Infotext
 Key, 84

Initial commissioning, 74
Installation guidelines, 44
Installation information, 44
Installation of operating system
 Windows 7, 123
Installing
 HMI device, 52
Installing language package, (See MUI)
Insulation testing
 Test voltage, 156
Integration
 Ethernet, 67
 Industrial Ethernet, 67
 PROFIBUS, 67
 PROFINET, 67
Interfaces, 148, 154
 CFast card, 159
 COM1, 159
 COM2, 159
 DisplayPort, 160
 DVI-I, 161
 PROFIBUS, 163
 PROFINET, 164
 USB 2.0, 163
 USB 3.0, 162
Interference emission, 146, 153
IPC477D Pro 19"
 Bottom view, 23
 Front view, 23
 Rear view, 23
IPC477D Pro 19" Touch
 Main dimensions, 138
IT communication, 67

K

Key
 ACK, 84
 ALT, 84
 Cancel, 84
 CTRL, 84
 Cursor, 85
 Delete, 84, 84
 END, 85
 ENTER, 84
 ESC, 84
 HOME, 85
 Scroll back, 85
 Scroll forward, 85
 SHIFT, 84
 Switching, 84

Keys

- Alphanumeric, 83
- Control keys, 84
- Cursor keys, 85

L

- Labeling, 132
 - Function key, 41
 - Korea, 132
- Labeling strips, 13
 - Attaching, 41
- License key, 122
- Limitation of liability, 111

M

- Main dimensions
 - IPC477D Pro 19" Touch, 138
- Main memory, 147, 153
- Marking
 - EC Declaration of Conformity, 131
- Membrane keyboard, 13
- Memory media
 - Drives, 147, 153
- Memory modules, 147, 153
- Messages
 - On the screen, 182
- Monitoring functions, 86
- Motherboard, 147, 153
- Mounting
 - Device, 47
 - with latch fasteners, 49
- Mounting clip
 - Mounting, 47
- Mounting cutout
 - Dimensions, 40
 - Preparing, 40
- Mounting position
 - PRO device, 43
- MP 377 15 PRO
 - Side view, 23
- MRAM, 92
- MUI, 124

N

- New Zealand, 132
- Note, 44
 - General Information, 32
 - Installation guidelines, 44

O

- On-screen error messages, 182
- Opening
 - Device, 95
- Operating system
 - Initial commissioning, 74
 - Updates, 129, 129
- Operating system requirements, 76
 - KeyTools, 76
- Operation
 - Capacitive multi-touch screen, 81
 - Single touch screen, 80
 - Touch screen, 79

P

- Package contents, 35
 - Checking, 35
- Packaging, 35
 - Checking, 35
 - Removing, 35
- Partitioning
 - Adapting, 128
 - CFast card, 127
 - SSD, 127, 128
 - Windows 7 Ultimate, 127
 - Windows Embedded Standard 7, 127
- PE conductor, 81
- Pixel, 33
 - Defective pixel, 33
- Ports
 - RJ45 Ethernet, 162
- Power disconnection, 58
- Processor, 147, 153
- PROFIBUS, 67
 - Integration, 67
 - Interface, 163
- PROFINET, 36, 67, 68, 167, 169
 - Interface, 164
- Protection class, 156
- Protective conductor, 56
 - Connecting, 56
- Protective measure
 - Static electricity, 134

R

- Radiation, 30
 - High-frequency radiation, 30
- Rated voltage, 156
- Rear view, 23

Recovery DVD, 121
Repairs, 109
Resolution, 12
Restore CD, 126
Restore CD/DVD for Windows Embedded Standard, 122
Restore DVD, 121
RS 422 to RS 232 converter, 26

S

Safety information
Storage, 36
Transportation, 36
Scope, 3
Scroll back key, 85
Scroll forward key, 85
Serial number, 36
Setting up partitions
Windows 7, 124
Setup, (BIOS Setup)
Shift key, 84
SHIFT key, 84
Side view, 23
SIMATIC NET, 67
SIMATIC S7, 67, 67
Integration, 67, 67
Single touch screen
Operation, 80
SSD
Partitioning, 127, 128
Standard mounting position, 38, 43
Startup, 182
Static electricity
Protective measures, 134
Supply voltage, 58
Support arm system, 27
Adapter set VESA 100, 27
Adapter set VESA 75, 27
Base adapter, 27
BERNSTEIN adaptation, 27
RITTAL adapter, 27
ROLEC adapter, 27
System partition, 122
System resources, 166

T

Temperature monitoring, 86

Terminal compartment cover, 62
Closing, 63
Opening, 62
Test voltage, 156
TFT technology, 11
Third-party expansion cards, 191
Touch screen
Operation, 79
Trigger register
Watchdog, 167

U

Update,
Updates
Application programs and drives, 130
Operating system, 129, 129
USB 2.0
Interface, 163
USB 3.0
Interface, 162
User Account Control, 75

V

Ventilation slits, 44

W

Warranty, 29
Watchdog, 87
Enable register, 168
Monitoring function, 87
Monitoring times, 87
Trigger register, 167
Windows 7
Installation, 123
Windows 7 Ultimate
Data backup, 130
Partitioning, 127
Windows Action Center, 75
Windows Embedded Standard
Data backup, 130
Windows Embedded Standard 7
Setting up partitions, 127
Windows XP Professional
Data backup, 130
Wiring information, 58